

TOSHIBA

FILE No. AEO-2103W
Revision 1: May, 2021

AIR-CONDITIONER SPLIT TYPE **Service Manual**

Model name: _____

Outdoor unit

<SUPER DIGITAL INVERTER>

RAV-GP561ATW-E

RAV-GP561ATW-TR

RAV-GP801ATW-E

RAV-GP801ATW-TR

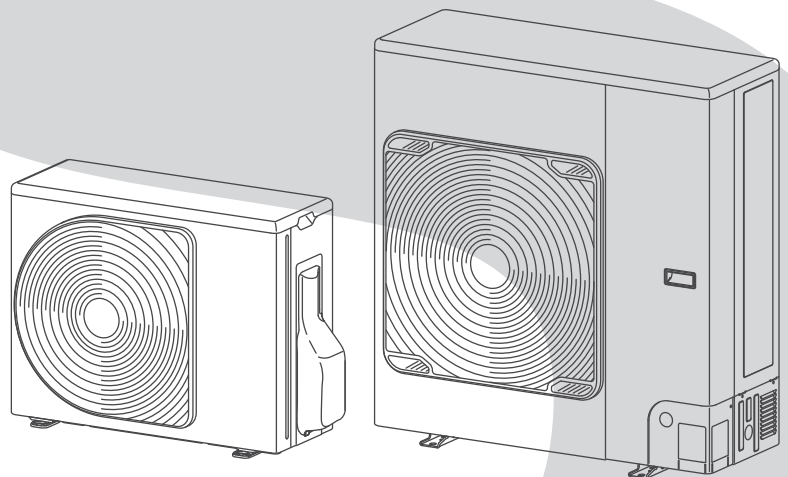

Contents

SAFETY CAUTION	4
1 SPECIFICATIONS	18
1-1.Indoor Unit	18
1-1-1.4-Way Smart Cassette <Single type>	18
1-1-2.4-Way Cassette <Single type>	19
1-1-3.Compact 4-Way Cassette <Single type>	20
1-1-4.Compact 4-Way Cassette <Twin type>	21
1-1-5.Slim Duct <Single type>	22
1-1-6.Slim Duct <Twin type>	23
1-1-7.Duct <Single type>	24
1-1-8.Ceiling <Single type>	25
1-1-9.Ceiling <Twin type>	26
1-1-10.High Wall <Single type>	27
1-1-11.Floor Standing <Single type>	28
1-2.Outdoor Unit	29
1-3.Operation Characteristic Curve	30
2 CONSTRUCTION VIEWS (EXTERNAL VIEWS)	32
2-1.RAV-GP561ATW*	32
2-2.RAV-GP801ATW*	33
2-3.Branch pipe	34
3 OUTDOOR UNIT REFRIGERANTING CYCLE DIAGRAM	35
4 WIRING DIAGRAM	38
4-1.RAV-GP561ATW*	38
4-2.RAV-GP801ATW*	39
5 SPECIFICATIONS OF ELECTRICAL PARTS	40
5-1.Outdoor Unit	40
5-2.Winding resistance of outdoor unit main parts	41
6 REFRIGERANT R32	42
6-1.Safety During Installation / Servicing	42
6-2.Refrigerant Piping Installation	42
6-2-1.Piping Materials and Joints Used	42
6-2-2.Processing of Piping Materials	43
6-3.Tools	46
6-3-1.Required Tools	46
6-4.Recharging of Refrigerant	46
6-5.Brazing of Pipes	47
6-5-1.Materials for Brazing	47
6-5-2.Flux	47
6-5-3.Brazing	48
6-6.Instructions for Re-use Piping of R22 or R407C	49
6-6-1.Basic Conditions Needed to Reuse the Existing Pipe	49
6-6-2.Restricted Items to Use the Existing Pipes	49
6-6-3.Branching Pipe for Simultaneous Operation System	49
6-6-4.Curing of Pipes	49

6-6-5.Final Installation Checks	50
6-6-6.Handling of Existing Pipe	51
6-6-7.Recovering Refrigerant	51
6-7.Charging additional refrigerant	51
6-7-1.[Assumed gas leak].	51
6-7-2.[Limiting the additional charge]	51
6-7-3.[Cautions on charging additional refrigerant]	51
6-8.General safety precautions for using R32 refrigerant	52
6-8-1.Recovery	52
6-8-2.Decommissioning	52
6-8-3.Labelling	52
7 CIRCUIT CONFIGURATION AND CONTROL SPECIFICATIONS	53
7-1.Outdoor Unit Control.	53
7-1-1.Print Circuit Board, MCC-1768	53
7-1-2.Print Circuit Board, MCC-1705	54
7-2.Outline of Main Controls	55
8 TROUBLESHOOTING	61
8-1.Summary of Troubleshooting	61
8-2.Troubleshooting	63
8-2-1.Outline of judgment.	63
8-2-2.Others (Other than Check Code)	65
8-2-3.Monitor Function of Remote Controller Switch	66
8-2-4.Check Code List (Outdoor)	67
8-2-5.Diagnostic Procedure for Each Check Code (Outdoor Unit).	73
9 SETUP AT LOCAL SITE AND OTHERS	84
9-1.Calling of Check code History	84
9-2.Outdoor Unit	86
10 ADDRESS SETUP	95
10-1.Address Setup Procedure	95
10-2.Address Setup & Group Control.	96
10-2-1.System Configuration	97
10-2-2.Automatic Address Example from Unset Address (No miswiring)	98
10-3.Remote Controller Wiring	98
10-4.Address Setup (Manual setting from remote controller)	99
10-5.Confirmation of Indoor Unit No. Position	100
11 REPLACEMENT OF THE SERVICE P.C. BOARD	102
12 HOW TO EXCHANGE COMPRESSOR	104
12-1.Exchanging Procedure of Compressor (Outline)	104
13 DETACHMENTS	105
13-1.RAV-GP561ATW*	105
13-2.RAV-GP801ATW*	113
14 EXPLODED VIEWS AND PARTS LIST	125
14-1.Outdoor Unit	125
14-2.Inverter Assembly	129

SAFETY CAUTION

Please read carefully through these instructions that contain important information which complies with the “Machinery Directive” (Directive 2006/42/EC), and ensure that you understand them.

Some of the details provided in these instructions differ from the service manual, and the instructions provided here take precedence.

Generic Denomination: Air Conditioner

Definition of Qualified Installer or Qualified Service Person

The air conditioner must be installed, maintained, repaired and removed by a qualified installer or qualified service person.

When any of these jobs is to be done, ask a qualified installer or qualified service person to do them.

A qualified installer or qualified service person is an agent who has the qualifications and knowledge described in the table below.

Agent	Qualifications and knowledge which the agent must have
Qualified installer (*1)	<ul style="list-style-type: none"> • The qualified installer is a person who installs, maintains, relocates and removes the air conditioners made by Toshiba Carrier Air-conditioning Europe Sp. z o.o. He or she has been trained to install, maintain, relocate and remove the air conditioners made by Toshiba Carrier Air-conditioning Europe Sp. z o.o. or, alternatively, he or she has been instructed in such operations by an individual or individuals who have been trained and is thus thoroughly acquainted with the knowledge related to these operations. • The qualified installer who is allowed to do the electrical work involved in installation, relocation and removal has the qualifications pertaining to this electrical work as stipulated by the local laws and regulations, and he or she is a person who has been trained in matters relating to electrical work on the air conditioners made by Toshiba Carrier Air-conditioning Europe Sp. z o.o. or, alternatively, he or she has been instructed in such matters by an individual or individuals who have been trained and is thus thoroughly acquainted with the knowledge related to this work. • The qualified installer who is allowed to do the refrigerant handling and piping work involved in installation, relocation and removal has the qualifications pertaining to this refrigerant handling and piping work as stipulated by the local laws and regulations, and he or she is a person who has been trained in matters relating to refrigerant handling and piping work on the air conditioners made by Toshiba Carrier Air-conditioning Europe Sp. z o.o. or, alternatively, he or she has been instructed in such matters by an individual or individuals who have been trained and is thus thoroughly acquainted with the knowledge related to this work. • The qualified installer who is allowed to work at heights has been trained in matters relating to working at heights with the air conditioners made by Toshiba Carrier Air-conditioning Europe Sp. z o.o. or, alternatively, he or she has been instructed in such matters by an individual or individuals who have been trained and is thus thoroughly acquainted with the knowledge related to this work.
Qualified service person (*1)	<ul style="list-style-type: none"> • The qualified service person is a person who installs, repairs, maintains, relocates and removes the air conditioners made by Toshiba Carrier Air-conditioning Europe Sp. z o.o. He or she has been trained to install, repair, maintain, relocate and remove the air conditioners made by Toshiba Carrier Air-conditioning Europe Sp. z o.o. or, alternatively, he or she has been instructed in such operations by an individual or individuals who have been trained and is thus thoroughly acquainted with the knowledge related to these operations. • The qualified service person who is allowed to do the electrical work involved in installation, repair, relocation and removal has the qualifications pertaining to this electrical work as stipulated by the local laws and regulations, and he or she is a person who has been trained in matters relating to electrical work on the air conditioners made by Toshiba Carrier Air-conditioning Europe Sp. z o.o. or, alternatively, he or she has been instructed in such matters by an individual or individuals who have been trained and is thus thoroughly acquainted with the knowledge related to this work. • The qualified service person who is allowed to do the refrigerant handling and piping work involved in installation, repair, relocation and removal has the qualifications pertaining to this refrigerant handling and piping work as stipulated by the local laws and regulations, and he or she is a person who has been trained in matters relating to refrigerant handling and piping work on the air conditioners made by Toshiba Carrier Air-conditioning Europe Sp. z o.o. or, alternatively, he or she has been instructed in such matters by an individual or individuals who have been trained and is thus thoroughly acquainted with the knowledge related to this work. • The qualified service person who is allowed to work at heights has been trained in matters relating to working at heights with the air conditioners made by Toshiba Carrier Air-conditioning Europe Sp. z o.o. or, alternatively, he or she has been instructed in such matters by an individual or individuals who have been trained and is thus thoroughly acquainted with the knowledge related to this work.

Definition of Protective Gear

When the air conditioner is to be transported, installed, maintained, repaired or removed, wear protective gloves and 'safety' work clothing.



In addition to such normal protective gear, wear the protective gear described below when undertaking the special work detailed in the table below.

Failure to wear the proper protective gear is dangerous because you will be more susceptible to injury, burns, electric shocks and other injuries.

Work undertaken	Protective gear worn
All types of work	Protective gloves "Safety" working clothing
Electrical-related work	Gloves to provide protection for electricians Insulating shoes Clothing to provide protection from electric shock
Work done at heights (50 cm or more)	Helmets for use in industry
Transportation of heavy objects	Shoes with additional protective toecap
Repair of outdoor unit	Gloves to provide protection for electricians



The important contents concerned to the safety are described on the product itself and on this Service Manual. Please read this Service Manual after understanding the described items thoroughly in the following contents (Indications / Illustrated marks), and keep them.

[Explanation of indications]

Indication	Explanation
 DANGER	Indicates contents assumed that an imminent danger causing a death or serious injury of the repair engineers and the third parties when an incorrect work has been executed.
 WARNING	Indicates possibilities assumed that a danger causing a death or serious injury of the repair engineers, the third parties, and the users due to troubles of the product after work when an incorrect work has been executed.
 CAUTION	Indicates contents assumed that an injury or property damage (*) may be caused on the repair engineers, the third parties, and the users due to troubles of the product after work when an incorrect work has been executed.

* Property damage: Enlarged damage concerned to property, furniture, and domestic animal / pet

[Explanation of illustrated marks]





Mark	Explanation
	Indicates prohibited items (Forbidden items to do) The sentences near an illustrated mark describe the concrete prohibited contents.
	Indicates mandatory items (Compulsory items to do) The sentences near an illustrated mark describe the concrete mandatory contents.
	Indicates cautions (Including danger / warning) The sentences or illustration near or in an illustrated mark describe the concrete cautious contents.



Warning indications on the Air Conditioner Unit



[Confirmation of warning label on the main unit]

Confirm that labels are indicated on the specified positions

If removing the label during parts replace, stick it as the original.



	WARNING (Risk of fire)	This mark is for R32 refrigerant only. Refrigerant type is written on nameplate of outdoor unit. In case that refrigerant type is R32, this unit uses a flammable refrigerant. If refrigerant leaks and comes in contact with fire or heating part, it will create harmful gas and there is risk of fire.
	Read the OWNER'S MANUAL carefully before operation.	
	Service personnel are required to carefully read the OWNER'S MANUAL and INSTALLATION MANUAL before operation.	
	Further information is available in the OWNER'S MANUAL, INSTALLATION MANUAL, and the like.	

Warning indication		Description
	<p>WARNING</p> <p>ELECTRICAL SHOCK HAZARD</p> <p>Disconnect all remote electric power supplies before servicing.</p>	<p>WARNING</p> <p>ELECTRICAL SHOCK HAZARD</p> <p>Disconnect all remote electric power supplies before servicing.</p>
	<p>WARNING</p> <p>Moving parts. Do not operate unit with grille removed. Stop the unit before the servicing.</p>	<p>WARNING</p> <p>Moving parts. Do not operate unit with grille removed. Stop the unit before the servicing.</p>
	<p>CAUTION</p> <p>High temperature parts. You might get burned when removing this panel.</p>	<p>CAUTION</p> <p>High temperature parts. You might get burned when removing this panel.</p>

	<p style="text-align: center;">CAUTION</p> <hr/> <p>Do not touch the aluminum fins of the unit. Doing so may result in injury.</p>	<p>CAUTION</p> <p>Do not touch the aluminum fins of the unit. Doing so may result in injury.</p>
	<p style="text-align: center;">CAUTION</p> <hr/> <p>Do not touch the aluminum fins of the unit. You might get burned.</p>	<p>CAUTION</p> <p>Do not touch the aluminum fins of the unit. You might get burned.</p>
	<p style="text-align: center;">CAUTION</p> <hr/> <p style="text-align: center;">BURST HAZARD</p> <p>Open the service valves before the operation, otherwise there might be the burst.</p>	<p>CAUTION</p> <p>BURST HAZARD</p> <p>Open the service valves before the operation, otherwise there might be the burst.</p>



Precaution for Safety

The appliance shall be installed in accordance with national wiring regulations. Capacity shortages of the power circuit or an incomplete installation may cause an electric shock or fire.

 DANGER	
 Turn off breaker	<p>Before carrying out the installation, maintenance, repair or removal work, be sure to set the circuit breaker to the OFF position. Otherwise, electric shocks may result.</p>
	<p>Before opening the intake grille of the indoor unit or service panel of the outdoor unit, set the circuit breaker to the OFF position. Failure to set the circuit breaker to the OFF position may result in electric shocks through contact with the interior parts. Only a qualified installer (*1) or qualified service person (*1) is allowed to remove the intake grille of the indoor unit or service panel of the outdoor unit and do the work required.</p>
	<p>Before starting to repair the outdoor unit fan or fan guard, be absolutely sure to set the circuit breaker to the OFF position, and place a "Work in progress" sign on the circuit breaker.</p>
	<p>When cleaning the filter or other parts of the indoor unit, set the circuit breaker to OFF without fail, and place a "Work in progress" sign near the circuit breaker before proceeding with the work.</p>
 Prohibition	<p>Do not turn ON the circuit breaker under the condition of removing a cabinet, a panel, etc. Otherwise, it leads to an electric shock with a high voltage, resulting in loss of life.</p>







(*1) Refer to the "Definition of Qualified Installer or Qualified Service Person".

WARNING

 General	<p>Before starting to repair the air conditioner, read carefully through the Service Manual, and repair the air conditioner by following its instructions.</p>
	<p>Only qualified service person (*1) is allowed to repair the air conditioner. Repair of the air conditioner by unqualified person may give rise to a fire, electric shocks, injury, water leaks and/or other problems.</p>
	<p>Only a qualified installer (*1) or qualified service person (*1) is allowed to carry out the electrical work of the air conditioner. Under no circumstances must this work be done by an unqualified individual since failure to carry out the work properly may result in electric shocks and/or electrical leaks.</p>
	<p>Wear protective gloves and safety work clothing during installation, servicing and removal.</p>
	<p>When connecting the electrical wires, repairing the electrical parts or undertaking other electrical jobs, wear gloves to provide protection for electricians, insulating shoes and clothing to provide protection from electric shocks. Failure to wear this protective gear may result in electric shocks.</p>
	<p>Use wiring that meets the specifications in the Installation Manual and the stipulations in the local regulations and laws. Use of wiring which does not meet the specifications may give rise to electric shocks, electrical leakage, smoking and/or a fire.</p>
	<p>Only a qualified installer (*1) or qualified service person (*1) is allowed to undertake work at heights using a stand of 50 cm or more.</p>
	<p>When working at heights, use a ladder which complies with the ISO 14122 standard, and follow the procedure in the ladder's instructions. Also wear a helmet for use in industry as protective gear to undertake the work.</p>
	<p>When working at heights, put a sign in place so that no-one will approach the work location, before proceeding with the work. Parts and other objects may fall from above, possibly injuring a person below.</p>
	<p>Do not touch the aluminum fin of the outdoor unit. You may injure yourself if you do so. If the fin must be touched for some reason, first put on protective gloves and safety work clothing, and then proceed.</p>
	<p>Do not climb onto or place objects on top of the outdoor unit. You may fall or the objects may fall of the outdoor unit and result in injury.</p>
	<p>When transporting the air conditioner, wear shoes with additional protective toecap.</p>
	<p>When transporting the air conditioner, do not hold the bands around the packing carton. You may injure yourself if the bands should break.</p>
	<p>This air conditioner has passed the pressure test as specified in IEC 60335-2-40 Annex EE.</p>
 Electric shock hazard	<p>When you access inside of the electric cover to repair electric parts, wait for about five minutes after turning off the breaker. Do not start repairing immediately. Otherwise you may get electric shock by touching terminals of high-voltage capacitors. Natural discharge of the capacitor takes about five minutes.</p>
 Prohibition	<p>Place a "Work in progress" sign near the circuit breaker while the installation, maintenance, repair or removal work is being carried out. There is a danger of electric shocks if the circuit breaker is set to ON by mistake.</p> <p>When checking the electric parts, removing the cover of the electric parts box of Indoor Unit and/or front panel of Outdoor Unit inevitably to determine the failure, put a sign "Do not enter" around the site before the work. Failure to do this may result in third person getting electric shock.</p> <p>Before operating the air conditioner after having completed the work, check that the electrical parts box cover of the indoor unit and service panel of the outdoor unit are closed, and set the circuit breaker to the ON position. You may receive an electric shock if the power is turned on without first conducting these checks.</p>





(*1) Refer to the "Definition of Qualified Installer or Qualified Service Person".

WARNING





 Stay on protection	<p>If, in the course of carrying out repairs, it becomes absolutely necessary to check out the electrical parts with the electrical parts box cover of one or more of the indoor units and the service panel of the outdoor unit removed in order to find out exactly where the trouble lies, wear insulated heat-resistant gloves, insulated boots and insulated work overalls, and take care to avoid touching any live parts.</p> <p>You may receive an electric shock if you fail to heed this warning. Only qualified service person (*1) is allowed to do this kind of work.</p>
 Check earth wires	<p>Before troubleshooting or repair work, check the earth wire is connected to the earth terminals of the main unit, otherwise an electric shock is caused when a leak occurs. If the earth wire is not correctly connected, contact an electric engineer for rework.</p> <p>After completing the repair or relocation work, check that the earth wires are connected properly.</p> <p>Be sure to connect earth wire. (Grounding work) Incomplete earthing causes an electric shock. Do not connect earth wires to gas pipes, water pipes, and lightning rods or earth wires for telephone wires.</p>
 Prohibition of modification	<p>Do not modify the products. Do not also disassemble or modify the parts. It may cause a fire, electric shock or injury.</p>
 Use specified parts	<p>When any of the electrical parts are to be replaced, ensure that the replacement parts satisfy the specifications given in the Service Manual (or use the parts contained on the parts list in the Service Manual). Use of any parts which do not satisfy the required specifications may give rise to electric shocks, smoking and/or a fire.</p> <p>Replace components only with parts specified by the manufacturer. Other parts may result in the ignition of refrigerant in the atmosphere due to the refrigerant leak.</p>
 Do not bring a child close to the equipment	<p>If, in the course of carrying out repairs, it becomes absolutely necessary to check out the electrical parts with the electrical parts box cover of one or more of the indoor units and the service panel of the outdoor unit removed in order to find out exactly where the trouble lies, place "Keep out" signs around the work site before proceeding. Third-party individuals may enter the work site and receive electric shocks if this warning is not heeded.</p>
 Insulating measures	<p>Connect the cut-off lead wires with crimp contact, etc, put the closed end side upward and then apply a water-cut method, otherwise a leak or production of fire is caused at the user's side.</p>
 No fire	<p>When performing repairs using a gas burner, replace the refrigerant with nitrogen gas because the oil that coats the pipes may otherwise burn. When repairing the refrigerating cycle, take the following measures.</p> <ol style="list-style-type: none"> 1) Be attentive to fire around the cycle. When using a gas stove, etc, be sure to put out fire before work; otherwise the oil mixed with refrigerant gas may catch fire. 2) Do not use a brazing in the closed room. When using it without ventilation, carbon monoxide poisoning may be caused. 3) Do not bring inflammables close to the refrigerant cycle, otherwise fire of the brazing may catch the inflammables.

(*1) Refer to the "Definition of Qualified Installer or Qualified Service Person".

WARNING



 Refrigerant	<p>The refrigerant used by this air conditioner is the R32.</p>
	<p>Check the used refrigerant name and use tools and materials of the parts which match with it. For the products which use R32 refrigerant, the refrigerant name is indicated at a position on the outdoor unit where is easy to see. To prevent miss charging, the route of the service port is changed from one of the former R22. Be careful for miss charging since a charging port of R32 is the same diameter as that of R410A.</p>
	<p>Do not use any refrigerant different from the one specified for complement or replacement. Otherwise, abnormally high pressure may be generated in the refrigeration cycle, which may result in a failure or explosion of the product or an injury to your body.</p>
	<p>For an air conditioner which uses R32, never use other refrigerant than R32. For an air conditioner which uses other refrigerant (R22, R410A etc.), never use R32. If different types of refrigerant are mixed, abnormal high pressure generates in the refrigerating cycle and an injury due to breakage may be caused. If the different type of refrigerants are mixed in, be sure to recharge the refrigerant.</p>
	<p>Do not charge refrigerant additionally. If charging refrigerant additionally when refrigerant gas leaks, the refrigerant composition in the refrigerating cycle changes resulted in change of air conditioner characteristics or refrigerant over the specified standard amount is charged and an abnormal high pressure is applied to the inside of the refrigerating cycle resulted in cause of breakage or injury. Therefore if the refrigerant gas leaks, recover the refrigerant in the air conditioner, execute vacuuming, and then newly recharge the specified amount of liquid refrigerant. In this time, never charge the refrigerant over the specified amount.</p>
	<p>When recharging the refrigerant in the refrigerating cycle, do not mix the refrigerant or air other than R32 into the specified refrigerant. If air or others is mixed with the refrigerant, abnormal high pressure generates in the refrigerating cycle resulted in cause of injury due to breakage.</p>
	<p>After the installation work, confirm that refrigerant gas does not leak. If refrigerant gas leaks into the room and flows near a fire source, such as a cooking range, it may generate noxious gases, causing a fire.</p>
	<p>Never recover the refrigerant into the outdoor unit. When the equipment is moved or repaired, be sure to recover the refrigerant with recovering device. The refrigerant cannot be recovered in the outdoor unit; otherwise a serious accident such as breakage or injury is caused.</p>
 Assembly / Cabling	<p>After repair work, surely assemble the disassembled parts, the removed lead wires and wiring processing as before. Perform the work so that the cabinet or panel does not catch the inner wires. If incorrect assembly or incorrect wire connection was done, a disaster such as a leak or fire is caused at user's side.</p>
 Insulator check	<p>After the work has finished, be sure to use an insulation tester set (500V Megger) to check the resistance is 1 MΩ or more between the charge section and the non-charge metal section (Earth position). If the resistance value is low, a disaster such as a leak or electric shock is caused at user's side.</p>
 Ventilation	<p>When the refrigerant gas leaks during work, execute ventilation. If the refrigerant gas touches to a fire, it may generate noxious gases, causing a fire. A case of leakage of the refrigerant and the closed room full with gas is dangerous because a shortage of oxygen occurs. Be sure to execute ventilation.</p> <p>If refrigerant gas has leaked during the installation work, ventilate the room immediately. If the leaked refrigerant gas comes in contact with fire, it may generate noxious gases, causing a fire.</p>

WARNING

 Compulsion	<p>When the refrigerant gas leaks, find out the leaked position and repair it surely. If the leaked position cannot be found out and the repair work is interrupted, reclaim and tighten the service valve, otherwise the refrigerant gas may leak into the room. When gas touches to fire such as fan heater, stove or cooking stove, it may generate noxious gases, causing a fire though the refrigerant gas itself is innocuous. When installing equipment which includes a large amount of charged refrigerant in a sub-room, it is necessary that the concentration does not the limit even if the refrigerant leaks. If the refrigerant leaks and exceeds the limit concentration, an accident of shortage of oxygen is caused.</p> <p>Tighten the flare nut with a torque wrench in the specified manner. Excessive tighten of the flare nut may cause a crack in the flare nut after a long period, which may result in refrigerant leakage.</p> <p>Nitrogen gas must be used for the airtight test.</p> <p>The charge hose must be connected in such a way that it is not slack.</p> <p>For the installation / moving / reinstallation work, follow to the Installation Manual. If an incorrect installation is done, a trouble of the refrigerating cycle, water leak, electric shock or fire is caused.</p> <p>Install the outdoor unit properly in a location that is durable enough to support the weight of the outdoor unit. Insufficient durability may cause the outdoor unit to fall, which may result in injury.</p>
 Check after repair	<p>Once the repair work has been completed, check for refrigerant leaks, and check the insulation resistance and water drainage. Then perform a trial run to check that the air conditioner is running properly.</p> <p>After repair work has finished, check there is no trouble. If check is not executed, a fire, electric shock or injury may be caused. For a check, turn off the power breaker.</p> <p>After repair work (installation of front panel and cabinet) has finished, execute a test run to check there is no generation of smoke or abnormal sound. If check is not executed, a fire or an electric shock is caused. Before test run, install the front panel and cabinet.</p>
 Do not operate the unit with the valve closed	<p>Check the following matters before a test run after repairing piping.</p> <ul style="list-style-type: none"> • Connect the pipes surely and there is no leak of refrigerant. • The valve is opened. <p>Running the compressor under condition that the valve closes causes an abnormal high pressure resulted in damage of the parts of the compressor and etc. and moreover if there is leak of refrigerant at connecting section of pipes, the air is suctioned and causes further abnormal high pressure resulted in burst or injury.</p>
 Check after reinstallation	<p>Only a qualified installer (*1) or qualified service person (*1) is allowed to relocate the air conditioner. It is dangerous for the air conditioner to be relocated by an unqualified individual since a fire, electric shocks, injury, water leakage, noise and/or vibration may result.</p> <p>Check the following items after reinstallation.</p> <ol style="list-style-type: none"> 1) The earth wire is correctly connected. 2) The power cord is not caught in the product. 3) There is no inclination or unsteadiness and the installation is stable. <p>If check is not executed, a fire, an electric shock or an injury is caused.</p>
 Cooling check	<p>When the service panel of the outdoor unit is to be opened in order for the compressor or the area around this part to be repaired immediately after the air conditioner has been shut down, set the circuit breaker to the OFF position, and then wait at least 10 minutes before opening the service panel. If you fail to heed this warning, you will run the risk of burning yourself because the compressor pipes and other parts will be very hot to the touch. In addition, before proceeding with the repair work, wear the kind of insulated heat-resistant gloves designed to protect electricians.</p> <p>When the service panel of the outdoor unit is to be opened in order for the fan motor, reactor, inverter or the areas around these parts to be repaired immediately after the air conditioner has been shut down, set the circuit breaker to the OFF position, and then wait at least 10 minutes before opening the service panel. If you fail to heed this warning, you will run the risk of burning yourself because the fan motor, reactor, inverter heat sink and other parts will be very hot to the touch. In addition, before proceeding with the repair work, wear the kind of insulated heat-resistant gloves designed to protect electricians.</p>



(*1) Refer to the "Definition of Qualified Installer or Qualified Service Person".

WARNING

 Installation	Only a qualified installer (*1) or qualified service person (*1) is allowed to install the air conditioner. If the air conditioner is installed by an unqualified individual, a fire, electric shocks, injury, water leakage, noise and/or vibration may result.
	Before starting to install the air conditioner, read carefully through the Installation Manual, and follow its instructions to install the air conditioner.
	Do not install the air conditioner in a location that may be subject to a risk of expire to a combustible gas. If a combustible gas leaks and becomes concentrated around the unit, a fire may occur.
	When transporting the air conditioner, use a forklift truck and when moving the air conditioner by hand, move the unit with 4 people.
	Install a circuit breaker that meets the specifications in the Installation Manual and the stipulations in the local regulations and laws.
	Install the circuit breaker where it can be easily accessed by the agent.
 Compulsion	When carrying out the reclaim work shut down the compressor before disconnecting the refrigerant pipe. Disconnecting the refrigerant pipe with the service valve left open and the compressor still operating will cause air, etc. to be sucked in, raising the pressure inside the refrigeration cycle to an abnormally high level, and possibly resulting in rupture, injury, etc.
	When removing the brazing parts of suction and discharge pipe for the compressor, remove them at the place ventilated well after recovering the refrigerant. Improper recovering may cause the spurt of the refrigerant and the refrigeration oil, causing an injury.
 Prohibition	Do not vent gases to the atmosphere. Venting gases to the atmosphere is prohibited by the law.

(*1) Refer to the "Definition of Qualified Installer or Qualified Service Person".

CAUTION

 Wearing of gloves	Ensure wearing of gloves when performing any work in order to avoid injury from parts, etc. Failure to wear the proper protective gloves cause an injury due to the parts, etc.
 Confirm	When performing the brazing work, check whether refrigerant leaks or remains. If the leakage refrigerant gas touches a fire source, it may generate noxious gases, causing a fire.

Explanations given to user

- If you have discovered that the fan grille is damaged, do not approach the outdoor unit but set the circuit breaker to the OFF position, and contact a qualified service person to have the repairs done.
Do not set the circuit breaker to the ON position until the repairs are completed.

Relocation

- Only a qualified installer (*1) or qualified service person (*1) is allowed to relocate the air conditioner.
It is dangerous for the air conditioner to be relocated by an unqualified individual since a fire, electric shocks, injury, water leakage, noise and/or vibration may result.
- When carrying out the reclaim work shut down the compressor before disconnecting the refrigerant pipe.
Disconnecting the refrigerant pipe with the service valve left open and the compressor still operating will cause air, etc. to be sucked in, raising the pressure inside the refrigeration cycle to an abnormally high level, and possibly resulting in rupture, injury, etc.

(*1) Refer to the "Definition of Qualified Installer or Qualified Service Person".

Declaration of Conformity

Manufacturer: Toshiba Carrier Air-conditioning Europe Sp. z o.o.
ul. Gdańska 131, 62-200 Gniezno, Poland

TCF holder: Toshiba Carrier Air-conditioning Europe Sp. z o.o.
ul. Gdańska 131, 62-200 Gniezno, Poland

Hereby declares that the machinery described below:

Generic Denomination: Air Conditioner

Model / type: RAV-GP561ATW-E, RAV-GP801ATW-E
RAV-GP561ATW-TR, RAV-GP801ATW-TR

Commercial name: Super Digital Inverter Series Air Conditioner

Complies with the provisions of the "Machinery Directive" (Directive 2006/42/EC) and the regulations transposing into national law.

Complies with the provisions of the following harmonized standard:

EN 378-2: 2016

Name: Morizono Takahiro

Position: GM, Quality Assurance & Design Engineering Dept.

Date: 13 April, 2021

Place Issued: Poland

Note: This declaration becomes invalid if technical or operational modifications are introduced without the manufacturer's consent.

Disposal

How to dispose of air conditioners in accordance with the 2002/96/EC Directive WEEE (Waste Electrical and Electronic Equipment) is provided in the manual supplied with your product.

Specifications

Model	Sound pressure level (dB(A))		Weight (kg)
	Cooling	Heating	
RAV-GP561ATW-E	*	*	45
RAV-GP801ATW-E	*	*	74
RAV-GP561ATW-TR	*	*	45
RAV-GP801ATW-TR	*	*	74

* Under 70 dB(A)

Refrigerant R32

This air conditioner adopts a new HFC type refrigerant (R32) which does not deplete the ozone layer.

(1) Safety Caution Concerned to Refrigerant R32

Be sure that water, dust, the former refrigerant or the former refrigerating oil is not mixed into the refrigerating cycle of the air conditioner with refrigerant R32 during installation work or service work.

If an incorrect work or incorrect service is performed, there is a possibility to cause a serious accident.

Use the tools and materials exclusive to R32 to purpose a safe work.

(2) Safety and Cautions on Installation / Service

<Safety items>

When gas concentration and ignition energy are happened at the same time, R32 has a slight possibility of burning. Although it will not ignite under normal work environment conditions, be aware that the flame spreads if ignition should occur.

It is necessary to carry out installation / servicing safely while taking the following precautions into consideration.

- (1) Never use refrigerant other than specified refrigerant (R32) in an air conditioner which is designed to operate with the specified refrigerant (R32).
If other refrigerant than R32 is used, it may cause personal injury, etc. by a malfunction, a fire, a rupture.
- (2) Since R32 is heavier than air, it tends to accumulate at the bottom (near the floor).
Ventilate properly for the working environment to prevent its combustion.
Especially in a basement or a closed room where is the high risk of the accumulation, ventilate the room with a local exhaust ventilation.
If refrigerant leakage is confirmed in the room or the place where the ventilation is insufficient, do not work until the proper ventilation is performed and the work environment is improved.
- (3) When performing brazing work, be sure to check for leakage refrigerant or residual refrigerant.
If the leakage refrigerant comes into contact with fire, a poisonous gas may occur or it may cause a fire.
Keep adequate ventilation during the work.
- (4) When refrigerant gas leaks during work, execute ventilation. If the leakage refrigerant comes into contact with a fire, a poisonous gas may occur or it may cause a fire.
- (5) In places where installing / repairing air-conditioning equipment, etc., keep the source of ignition such as gas combustion equipment, petroleum combustion equipment, electric heater etc. away. Do not smoke in the place.
- (6) When installing or removing an air conditioner, do not mix air in the refrigerant cycle.
If air or others is mixed with the refrigerant, abnormal high pressure generates in the refrigerating cycle, causing injury due to the breakage.
- (7) After installation work complete, confirm that refrigerant gas is not leaking on the flare connection part or others. If leaked refrigerant comes to contact with a fire, toxic gas may occur, causing a fire.
- (8) Perform the installation work and re-installation according to the installation manual.
Pay attention especially to the area of application. Improper installation may cause refrigeration trouble, water leakage, electric shock, or fire etc.
- (9) Unauthorized modifications to the air conditioner may be dangerous. If a breakdown occurs please call a qualified air conditioner technician or electrician.
Improper repair may result in water leakage, electric shock and fire, etc.
- (10) Carry out the airtight test with nitrogen at a specified pressure. Do not use oxygen or acetylene gas absolutely as it may cause an explosion.
- (11) Always carry a refrigerant leakage detection sensor during the work and work while checking that no refrigerant leaks around working environment.
- (12) If the leakage refrigerant comes into contact with fire, it may cause a fire.
Have a dry powder or CO² fire extinguisher adjacent to the charging area.

<Caution items>

- (1) The opposite side dimension of the air-conditioner’s flared nut using R32 and the shape of the charge port are the same as those of R410A.
- (2) Be careful not to charge refrigerant by mistake. Should the different type of refrigerant mix in, be sure to recharge the refrigerant.
- (3) Do not mix the other refrigerant or refrigerating oil with the refrigerant.
- (4) Since the pressure of R32 is 1.6 times higher than that of the former refrigerant (R22), use tools and parts with high pressure resistance specification similar to R410A.
- (5) In the installation time, use clean pipe materials and work with great attention so that water and others do not mix in because pipes are affected by impurities such as water, oxide film, oil, etc. Use the clean pipes. Be sure to braze while flowing nitrogen gas in the pipe. (Never use gas other than nitrogen gas.)
- (6) For the earth protection, use a vacuum pump for air purge.
- (7) R32 refrigerant is Single-component refrigerant that does not change its composition. Although it is possible to charge the refrigerant with either liquid or gas, charge it with liquid.

(3) Pipe Materials

For the refrigerant pipes, copper pipe and joints are mainly used.
 It is necessary to select the most appropriate pipes to conform to the standard.
 Use clean pipes or joints to which little impurities adhere.

(1) Copper pipe

<Piping>
 The pipe thickness, flare-finishing size, flare nut and others differ according to a refrigerant type.
 When using a long copper pipe for R32, it is recommended to select “Copper or copper-base pipe without seam” and one with bonded oil amount 40 mg / 10 m or less.
 Also do not use crushed, deformed, discolored (especially inside) pipes.
 (Impurities cause clogging of expansion valves and capillary tubes.)

<Flare nut>
 Use the flare nuts which are attached to the air conditioner unit.

Be sure to select the pipes with copper thickness in the table below since the pressure of an air conditioner using R32 is higher than that of R22.

Nominal diameter	Outer diameter (mm)	Thickness (mm) R410A or R32
1/4	6.4	0.80
3/8	9.5	0.80
1/2	12.7	0.80
5/8	15.9	1.00

Make sure not to use a thin copper pipe such as 0.7 mm copper thickness in the market.

(2) Joint

The flare joint and socket joint are used for joints of the copper pipe.
 The joints are rarely used for installation of the air conditioner.
 However clear impurities when using them.

(4) Tools

○: R410A tools available, △: Partly unavailable, ×: R410A tools unavailable

No.	Installation / service tools		Use	Applicability to R32 air conditioner or not	Applicability to R22 air conditioner or not
	Tools / Equipment	specification			
1	Flare tool	Clutch type	Pipe flaring	○	○
2	Copper pipe gauge for adjusting projection margin	—	Flaring by conventional flare tool	○	—
3	Torque wrench	—	Tightening of flare nut	○	×
4	Gauge manifold	Port size 1/2"-20UNF (5/16" Flare)	Evacuating, refrigerant charge, run check, etc.	○ Note 2	×
5	Charge hose	High-voltage		○	×
6	Vacuum pump	—	Vacuum drying	○ Note 3 1/2"-20UNF (5/16" Flare)	△ Connection diameter 1/4"
7	Vacuum pump adapter	—	Vacuum drying	○ Note 4 1/2"-20UNF (5/16" Flare)	△ Connection diameter 1/4"
8	Electronic balance for refrigerant charging	For 10 kg or 20 kg cylinder	Refrigerant charge	○	○
9	Leakage detector	—	Gas leakage check	○ Note 5	○ Note 5
10	Refrigerant cylinder	—	Refrigerant charge	× Note 6	×
11	Refrigerant recovery cylinder	Exclusive for R32	Refrigerant recovery container	× Note 7	×
12	Refrigerant recovery device	—	Refrigerant recovery device	○ Note 8	△ Connection diameter 1/4"

Note 1 When flaring is carried out for R410A or R32 using the conventional flare tools, adjustment of projection margin is necessary. For this adjustment, a copper pipe gauge, etc. are necessary.

Note 2 When saturation temperature is described, the gauge manifold differs for R410A and R32. If saturation temperature reading is required, special tools exclusive for R32 are required.

Note 3 Since R32 has a slight possibility of burning, be sure to use the tools corresponding to R32.

Note 4 Like R410, a Vacuum pump adapter needs installing to prevent a Vacuum pump oil (mineral oil) from flowing backward into the Charge hose. Mixing of the Vacuum pump oil into R32 refrigerant may cause a trouble such as generation of sludge, clogging of capillary, etc.

Note 5 Be sure to use those tools after confirming they correspond to each refrigerant.

Note 6 For a refrigerant cylinder exclusive for R32, the paint color (or label color) of the cylinder is set to the specified color (light blue) together with the indication of the refrigerant name.

Note 7 Although the container specification is the same as R410A, use a recovering container exclusive for R32 to avoid mixing with other refrigerants.

Note 8 Be careful for miss charging of the refrigerant during work. Miss-charging of the refrigerant type may cause not only damage of the equipment but also a fire etc.

▼ General tools

In addition to the above exclusive tools, the following equipment is necessary as the general tools.

- | | |
|-----------------------|---------------------------------|
| 1) Pipe cutter | 6) Spanner or Adjustable wrench |
| 2) Reamer | 7) Hole core drill |
| 3) Pipe bender | 8) Tape measure |
| 4) Level vial | 9) Metal saw |
| 5) Screwdriver (+, -) | |

Also prepare the following equipment for other installation method and run check.

- | | |
|----------------|--|
| 1) Clamp meter | 3) Insulation resistance tester (Megger) |
| 2) Thermometer | 4) Electro-scope |

1 SPECIFICATIONS

1-1. Indoor Unit

1-1-1. 4-Way Smart Cassette

<Single type>

Model		Indoor unit	RAV-GM	561UT*	801UT*
		Outdoor unit	RAV-GP	561ATW*	801ATW*
Cooling capacity			(kW)	5.0	7.1
Heating capacity			(kW)	5.6	8.0
Power supply			220 - 240 V ~, 50 Hz (Power supply from outdoor unit)		
Electrical characteristics	Cooling	Running current	(A)	5.72-5.24	6.70-6.14
		Power consumption	(kW)	1.20	1.37
		Power factor	(%)	94	93
		EER		4.17	5.18
		SEER		8.07	9.40
		Energy efficiency class (Lot10)		A++	A+++
	Heating	Running current	(A)	6.22-5.70	7.01-6.43
		Power consumption	(kW)	1.29	1.45
		Power factor	(%)	93	94
		COP		4.34	5.52
		SCOP		5.01	5.51
		Energy efficiency class (Lot10)		A++	A+++
		Maximum current	(A)	13.1	20.3
Indoor unit					
Fan unit	Fan			Turbo fan	Turbo fan
	Standard air flow (H/M+/M/L+/L)		(m ³ /min)	17.5/16.5/15.0/13.5/12.5	32.0/23.2/21.5/19.0/13.5
	Motor		(W)	60	130
Sound pressure level		(H/M+/M/L+/L)	(dB(A))	32/31/29/28/26	42/37/35/32/27
Sound power level		(H/M+/M/L+/L)	(dB(A))	48/47/45/44/43	56/50/49/46/43
Outdoor unit					
Length of refrigerant pipe	Max. total length		(m)	50	50
	Min. length		(m)	3	3
	Height difference	Outdoor lower	(m)	30	30
		Outdoor high	(m)	30	30
Fan unit	Fan			Propeller fan	Propeller fan
	Standard air flow high		(m ³ /min)	37.5	53
	Motor		(W)	43	60
Connecting pipe	Outdoor unit- Pipe branch	Gas side	(mm)	12.7	15.9
		Liquid side	(mm)	6.4	9.5
	Pipe branch- indoor unit	Gas side	(mm)	12.7	15.9
		Liquid side	(mm)	6.4	9.5
Sound pressure level		Cooling/Heating	(dB(A))	46/48	46/48
Sound power level		Cooling/Heating	(dB(A))	63/65	63/66

1-1-2. 4-Way Cassette <Single type>

Model		Indoor unit	RAV-RM	561UTP*	801UTP*
		Outdoor unit	RAV-GP	561ATW*	801ATW*
Cooling capacity			(kW)	5.0	7.1
Heating capacity			(kW)	5.6	8.0
Power supply			220 - 240 V ~, 50 Hz (Power supply from outdoor unit)		
Electrical characteristics	Cooling	Running current	(A)	6.04-5.54	7.72-7.08
		Power consumption	(kW)	1.22	1.58
		Power factor	(%)	93	93
		EER		4.10	4.49
		SEER		7.61	8.80
		Energy efficiency class (Lot10)		A++	A+++
	Heating	Running current	(A)	6.33-5.80	8.56-7.85
		Power consumption	(kW)	1.30	1.77
		Power factor	(%)	93	94
		COP		4.31	4.52
		SCOP		4.96	5.22
		Energy efficiency class (Lot10)		A++	A+++
		Maximum current	(A)	13.1	20.3
Indoor unit					
Fan unit	Fan			Turbo fan	Turbo fan
	Standard air flow (H/M+/M/L+/L)		(m ³ /min)	17.5/-/14.5/-/13.0	20.5/-/16.0/-/13.5
	Motor		(W)	14	20
Sound pressure level		(H/M+/M/L+/L)	(dB(A))	32/-/29/-/28	35/-/31/-/28
Sound power level		(H/M+/M/L+/L)	(dB(A))	47/-/44/-/43	50/-/46/-/43
Outdoor unit					
Length of refrigerant pipe	Max. total length		(m)	50	50
	Min. length		(m)	3	3
	Height difference	Outdoor lower	(m)	30	30
		Outdoor high	(m)	30	30
Fan unit	Fan			Propeller fan	Propeller fan
	Standard air flow high		(m ³ /min)	37.5	53
	Motor		(W)	43	60
Connecting pipe	Outdoor unit- Pipe branch	Gas side	(mm)	12.7	15.9
		Liquid side	(mm)	6.4	9.5
	Pipe branch- indoor unit	Gas side	(mm)	12.7	15.9
		Liquid side	(mm)	6.4	9.5
Sound pressure level		Cooling/Heating	(dB(A))	46/48	46/48
Sound power level		Cooling/Heating	(dB(A))	63/65	63/66

1-1-3. Compact 4-Way Cassette <Single type>

Model		Indoor unit	RAV-RM	561MUT*
		Outdoor unit	RAV-GP	561ATW*
Cooling capacity			(kW)	5.0
Heating capacity			(kW)	5.6
Power supply		220 - 240 V ~, 50 Hz (Power supply from outdoor unit)		
Electrical characteristics	Cooling	Running current	(A)	7.49-6.87
		Power consumption	(kW)	1.56
		Power factor	(%)	94
		EER		3.21
		SEER		6.12
		Energy efficiency class (Lot10)		A++
	Heating	Running current	(A)	7.68-7.04
		Power consumption	(kW)	1.60
		Power factor	(%)	95
		COP		3.50
		SCOP		4.30
		Energy efficiency class (Lot10)		A+
		Maximum current	(A)	13.1
Indoor unit				
Fan unit	Fan		Turbo fan	
	Standard air flow (H/M+/M/L+/L)		(m ³ /min)	13.3/12.0/11.2/9.4/9.1
	Motor		(W)	60
Sound pressure level		(H/M+/M/L+/L)	(dB(A))	44/42/39/36/35
Sound power level		(H/M+/M/L+/L)	(dB(A))	59/57/54/51/50
Outdoor unit				
Length of refrigerant pipe	Max. total length		(m)	50
	Min. length		(m)	3
	Height difference	Outdoor lower	(m)	30
		Outdoor high	(m)	30
Fan unit	Fan		Propeller fan	
	Standard air flow high		(m ³ /min)	37.5
	Motor		(W)	43
Connecting pipe	Outdoor unit- Pipe branch	Gas side	(mm)	12.7
		Liquid side	(mm)	6.4
	Pipe branch- indoor unit	Gas side	(mm)	12.7
		Liquid side	(mm)	6.4
Sound pressure level		Cooling/Heating	(dB(A))	46/48
Sound power level		Cooling/Heating	(dB(A))	63/65

1-1-4. Compact 4-Way Cassette <Twin type>

Model		Indoor unit	RAV-RM	401MUT*
		Indoor unit2	RAV-RM	401MUT*
		Outdoor unit	RAV-GP	801ATW*
Cooling capacity			(kW)	7.1
Heating capacity			(kW)	8.0
Power supply		220 - 240 V ~, 50 Hz (Power supply from outdoor unit)		
Electrical characteristics	Cooling	Running current	(A)	8.46-7.75
		Power consumption	(kW)	1.73
		Power factor	(%)	93
		EER		4.10
		SEER		7.80
		Energy efficiency class (Lot10)		A++
	Heating	Running current	(A)	8.80-8.07
		Power consumption	(kW)	1.82
		Power factor	(%)	94
		COP		4.40
		SCOP		4.86
		Energy efficiency class (Lot10)		A++
		Maximum current	(A)	20.8
Indoor unit				
Fan unit	Fan			Turbo fan
	Standard air flow (H/M+/M/L+/L)		(m ³ /min)	11.0/10.2/9.2/8.0/7.8
	Motor		(W)	60
Sound pressure level		(H/M+/M/L+/L)	(dB(A))	41/38/36/33/32
Sound power level		(H/M+/M/L+/L)	(dB(A))	56/53/51/48/47
Outdoor unit				
Length of refrigerant pipe	Max. total length		(m)	50
	Min. length		(m)	3
	Height difference	Outdoor lower	(m)	30
		Outdoor high	(m)	30
Fan unit	Fan			Propeller fan
	Standard air flow high		(m ³ /min)	53
	Motor		(W)	60
Connecting pipe	Outdoor unit- Pipe branch	Gas side	(mm)	15.9
		Liquid side	(mm)	9.5
	Pipe branch- indoor unit	Gas side	(mm)	12.7
		Liquid side	(mm)	6.4
Sound pressure level		Cooling/Heating	(dB(A))	46/48
Sound power level		Cooling/Heating	(dB(A))	63/66

1-1-5. Slim Duct
<Single type>

Model		Indoor unit	RAV-RM	561SDT*
		Outdoor unit	RAV-GP	561ATW*
Cooling capacity			(kW)	5.0
Heating capacity			(kW)	5.6
Power supply		220 - 240 V ~, 50 Hz (Power supply from outdoor unit)		
Electrical characteristics	Cooling	Running current	(A)	7.57-6.94
		Power consumption	(kW)	1.56
		Power factor	(%)	93
		EER		3.21
		SEER		5.77
		Energy efficiency class (Lot10)		A+
	Heating	Running current	(A)	7.81-7.15
		Power consumption	(kW)	1.58
		Power factor	(%)	93
		COP		3.54
		SCOP		4.20
		Energy efficiency class (Lot10)		A+
		Maximum current	(A)	13.1
Indoor unit				
Fan unit	Fan			Centrifugal fan
	Standard air flow (H/M+/M/L+/L)		(m ³ /min)	13.0/-/11.3/-/9.7
	Motor		(W)	60
Sound pressure level		(H/M+/M/L+/L)	(dB(A))	45/-/40/-/36
Sound power level		(H/M+/M/L+/L)	(dB(A))	55/-/53/-/48
Outdoor unit				
Length of refrigerant pipe	Max. total length		(m)	50
	Min. length		(m)	3
	Height difference	Outdoor lower	(m)	30
		Outdoor high	(m)	30
Fan unit	Fan			Propeller fan
	Standard air flow high		(m ³ /min)	37.5
	Motor		(W)	43
Connecting pipe	Outdoor unit- Pipe branch	Gas side	(mm)	12.7
		Liquid side	(mm)	6.4
	Pipe branch- indoor unit	Gas side	(mm)	12.7
		Liquid side	(mm)	6.4
Sound pressure level		Cooling/Heating	(dB(A))	46/48
Sound power level		Cooling/Heating	(dB(A))	63/65

1-1-6. Slim Duct <Twin type>

Model		Indoor unit	RAV-RM	401SDT*
		Indoor unit2	RAV-RM	401SDT*
		Outdoor unit	RAV-GP	801ATW*
Cooling capacity			(kW)	7.1
Heating capacity			(kW)	8.0
Power supply		220 - 240 V ~, 50 Hz (Power supply from outdoor unit)		
Electrical characteristics	Cooling	Running current	(A)	9.14-8.38
		Power consumption	(kW)	1.87
		Power factor	(%)	93
		EER		3.80
		SEER		6.50
		Energy efficiency class (Lot10)		A++
	Heating	Running current	(A)	8.80-8.07
		Power consumption	(kW)	1.82
		Power factor	(%)	94
		COP		4.40
		SCOP		4.51
Energy efficiency class (Lot10)			A+	
		Maximum current	(A)	20.8
Indoor unit				
Fan unit	Fan			Centrifugal fan
	Standard air flow (H/M+/M/L+/L)		(m ³ /min)	11.5/-/10.0/-/8.7
	Motor		(W)	60
Sound pressure level		(H/M+/M/L+/L)	(dB(A))	39/-/36/-/33
Sound power level		(H/M+/M/L+/L)	(dB(A))	52/-/48/-/44
Outdoor unit				
Length of refrigerant pipe	Max. total length		(m)	50
	Min. length		(m)	3
	Height difference	Outdoor lower	(m)	30
		Outdoor high	(m)	30
Fan unit	Fan			Propeller fan
	Standard air flow high		(m ³ /min)	53
	Motor		(W)	60
Connecting pipe	Outdoor unit- Pipe branch	Gas side	(mm)	15.9
		Liquid side	(mm)	9.5
	Pipe branch- indoor unit	Gas side	(mm)	12.7
		Liquid side	(mm)	6.4
Sound pressure level		Cooling/Heating	(dB(A))	46/48
Sound power level		Cooling/Heating	(dB(A))	63/66

1-1-7. Duct
<Single type>

Model		Indoor unit	RAV-RM	561BTP*	801BTP*
		Outdoor unit	RAV-GP	561ATW*	801ATW*
Cooling capacity			(kW)	5.0	7.1
Heating capacity			(kW)	5.6	8.0
Power supply		220 - 240 V ~, 50 Hz (Power supply from outdoor unit)			
Electrical characteristics	Cooling	Running current	(A)	7.36-6.75	7.97-7.30
		Power consumption	(kW)	1.52	1.63
		Power factor	(%)	92	93
		EER		3.29	4.36
		SEER		5.60	7.50
		Energy efficiency class (Lot10)		A+	A++
	Heating	Running current	(A)	7.66-7.03	8.95-8.20
		Power consumption	(kW)	1.61	1.85
		Power factor	(%)	94	94
		COP		3.48	4.32
		SCOP		4.24	4.81
		Energy efficiency class (Lot10)		A+	A++
		Maximum current	(A)	13.1	20.7
Indoor unit					
Fan unit	Fan			Centrifugal fan	Centrifugal fan
	Standard air flow (H/M+/M/L+/L)		(m ³ /min)	13.3/-/11.0/-/9.0	20.0/-/16.5/-/14.5
	Motor		(W)	150	150
Sound pressure level		(H/M+/M/L+/L)	(dB(A))	33/-/29/-/25	34/-/30/-/26
Sound power level		(H/M+/M/L+/L)	(dB(A))	55/-/51/-/46	55/-/51/-/46
Outdoor unit					
Length of refrigerant pipe	Max. total length		(m)	50	50
	Min. length		(m)	3	3
	Height difference	Outdoor lower	(m)	30	30
		Outdoor high	(m)	30	30
Fan unit	Fan			Propeller fan	Propeller fan
	Standard air flow high		(m ³ /min)	37.5	53
	Motor		(W)	43	60
Connecting pipe	Outdoor unit- Pipe branch	Gas side	(mm)	12.7	15.9
		Liquid side	(mm)	6.4	9.5
	Pipe branch- indoor unit	Gas side	(mm)	12.7	15.9
		Liquid side	(mm)	6.4	9.5
Sound pressure level		Cooling/Heating	(dB(A))	46/48	46/48
Sound power level		Cooling/Heating	(dB(A))	63/65	63/66

**1-1-8. Ceiling
<Single type>**

Model		Indoor unit	RAV-RM	561CTP*	801CTP*
		Outdoor unit	RAV-GP	561ATW*	801ATW*
Cooling capacity			(kW)	5.0	7.1
Heating capacity			(kW)	5.6	8.0
Power supply			220 - 240 V ~, 50 Hz (Power supply from outdoor unit)		
Electrical characteristics	Cooling	Running current	(A)	6.70-6.14	7.82-7.17
		Power consumption	(kW)	1.37	1.60
		Power factor	(%)	93	93
		EER		3.65	4.44
		SEER		6.76	7.95
		Energy efficiency class (Lot10)		A++	A++
	Heating	Running current	(A)	6.71-6.15	8.70-7.98
		Power consumption	(kW)	1.39	1.80
		Power factor	(%)	92	94
		COP		4.03	4.44
		SCOP		4.70	5.05
		Energy efficiency class (Lot10)		A++	A++
		Maximum current	(A)	13.1	20.6
Indoor unit					
Fan unit	Fan			Centrifugal fan	Centrifugal fan
	Standard air flow (H/M+/M/L+/L)		(m ³ /min)	15.0/-/12.0/-/9.0	23.5/-/16.7/-/12.5
	Motor		(W)	94	94
Sound pressure level		(H/M+/M/L+/L)	(dB(A))	37/-/35/-/28	41/-/36/-/29
Sound power level		(H/M+/M/L+/L)	(dB(A))	52/-/50/-/43	56/-/51/-/44
Outdoor unit					
Length of refrigerant pipe	Max. total length		(m)	50	50
	Min. length		(m)	3	3
	Height difference	Outdoor lower	(m)	30	30
		Outdoor high	(m)	30	30
Fan unit	Fan			Propeller fan	Propeller fan
	Standard air flow high		(m ³ /min)	37.5	53
	Motor		(W)	43	60
Connecting pipe	Outdoor unit- Pipe branch	Gas side	(mm)	12.7	15.9
		Liquid side	(mm)	6.4	9.5
	Pipe branch- indoor unit	Gas side	(mm)	12.7	15.9
		Liquid side	(mm)	6.4	9.5
Sound pressure level		Cooling/Heating	(dB(A))	46/48	46/48
Sound power level		Cooling/Heating	(dB(A))	63/65	63/66

1-1-9. Ceiling <Twin type>

Model		Indoor unit	RAV-RM	401CTP*
		Indoor unit2	RAV-RM	401CTP*
		Outdoor unit	RAV-GP	801ATW*
Cooling capacity			(kW)	7.1
Heating capacity			(kW)	8.0
Power supply		220 - 240 V ~, 50 Hz (Power supply from outdoor unit)		
Electrical characteristics	Cooling	Running current	(A)	7.82-7.17
		Power consumption	(kW)	1.60
		Power factor	(%)	93
		EER		4.44
		SEER		7.82
		Energy efficiency class (Lot10)		A++
	Heating	Running current	(A)	8.70-7.98
		Power consumption	(kW)	1.80
		Power factor	(%)	94
		COP		4.44
		SCOP		5.05
		Energy efficiency class (Lot10)		A++
		Maximum current	(A)	20.6
Indoor unit				
Fan unit	Fan			Centrifugal fan
	Standard air flow (H/M+/M/L+/L)		(m ³ /min)	15.0/-/12.0/-/9.0
	Motor		(W)	94
Sound pressure level		(H/M+/M/L+/L)	(dB(A))	37/-/35/-/28
Sound power level		(H/M+/M/L+/L)	(dB(A))	52/-/50/-/43
Outdoor unit				
Length of refrigerant pipe	Max. total length		(m)	50
	Min. length		(m)	3
	Height difference	Outdoor lower	(m)	30
		Outdoor high	(m)	30
Fan unit	Fan			Propeller fan
	Standard air flow high		(m ³ /min)	53
	Motor		(W)	60
Connecting pipe	Outdoor unit- Pipe branch	Gas side	(mm)	15.9
		Liquid side	(mm)	9.5
	Pipe branch- indoor unit	Gas side	(mm)	12.7
		Liquid side	(mm)	6.4
Sound pressure level		Cooling/Heating	(dB(A))	46/48
Sound power level		Cooling/Heating	(dB(A))	63/66

1-1-10.High Wall <Single type>

Model		Indoor unit	RAV-RM	561KRTP*	801KRTP*
		Outdoor unit	RAV-GP	561ATW*	801ATW*
Cooling capacity			(kW)	5.0	7.1
Heating capacity			(kW)	5.6	8.0
Power supply			220 - 240 V ~, 50 Hz (Power supply from outdoor unit)		
Electrical characteristics	Cooling	Running current	(A)	6.13-5.62	10.07-9.23
		Power consumption	(kW)	1.43	2.06
		Power factor	(%)	93	93
		EER		3.50	3.45
		SEER		7.59	7.34
		Energy efficiency class (Lot10)		A++	A++
	Heating	Running current	(A)	6.04-5.54	11.00-10.08
		Power consumption	(kW)	1.39	2.25
		Power factor	(%)	93	94
		COP		4.03	3.56
		SCOP		4.17	4.13
		Energy efficiency class (Lot10)		A+	A+
		Maximum current	(A)	13.1	20.6
Indoor unit					
Fan unit	Fan			Cross flow fan	Cross flow fan
	Standard air flow (H/M+/M/L+/L)		(m ³ /min)	16.0/-/13.8/-/11.3	17.3/-/15.2/-/11.3
	Motor		(W)	30	30
Sound pressure level		(H/M+/M/L+/L)	(dB(A))	42/41/39/36/35	45/43/41/36/35
Sound power level		(H/M+/M/L+/L)	(dB(A))	57/56/54/51/50	60/58/56/51/50
Outdoor unit					
Length of refrigerant pipe	Max. total length		(m)	50	50
	Min. length		(m)	3	3
	Height difference	Outdoor lower	(m)	30	30
		Outdoor high	(m)	30	30
Fan unit	Fan			Propeller fan	Propeller fan
	Standard air flow high		(m ³ /min)	37.5	53
	Motor		(W)	43	60
Connecting pipe	Outdoor unit- Pipe branch	Gas side	(mm)	12.7	15.9
		Liquid side	(mm)	6.4	9.5
	Pipe branch- indoor unit	Gas side	(mm)	12.7	15.9
		Liquid side	(mm)	6.4	9.5
Sound pressure level		Cooling/Heating	(dB(A))	46/48	46/48
Sound power level		Cooling/Heating	(dB(A))	63/65	63/66

1-1-11.Floor Standing <Single type>

Model		Indoor unit	RAV-RM	561FT*	801FT*
		Outdoor unit	RAV-GP	561ATW*	801ATW*
Cooling capacity			(kW)	5.0	7.1
Heating capacity			(kW)	5.6	8.0
Power supply			220 - 240 V ~, 50 Hz (Power supply from outdoor unit)		
Electrical characteristics	Cooling	Running current	(A)	6.94-6.36	9.97-9.14
		Power consumption	(kW)	1.42	2.04
		Power factor	(%)	93	93
		EER		3.51	3.48
		SEER		5.75	6.24
		Energy efficiency class (Lot10)		A+	A++
	Heating	Running current	(A)	8.06-7.39	11.46-10.51
		Power consumption	(kW)	1.65	2.37
		Power factor	(%)	93	94
		COP		3.39	3.38
		SCOP		4.20	4.41
		Energy efficiency class (Lot10)		A+	A+
		Maximum current	(A)	13.1	20.4
Indoor unit					
Fan unit	Fan			Centrifugal fan	Centrifugal fan
	Standard air flow (H/M+/M/L+/L)		(m ³ /min)	13.6/12.6/11.6/10.6/10.0	15.5/13.8/12.8/11.6/10.6
	Motor		(W)	62	62
Sound pressure level		(H/M+/M/L+/L)	(dB(A))	46/44/42/40/38	50/47/45/43/41
Sound power level		(H/M+/M/L+/L)	(dB(A))	60/58/56/54/52	64/61/60/57/54
Outdoor unit					
Length of refrigerant pipe	Max. total length		(m)	50	50
	Min. length		(m)	3	3
	Height difference	Outdoor lower	(m)	30	30
		Outdoor high	(m)	30	30
Fan unit	Fan			Propeller fan	Propeller fan
	Standard air flow high		(m ³ /min)	37.5	53
	Motor		(W)	43	60
Connecting pipe	Outdoor unit- Pipe branch	Gas side	(mm)	12.7	15.9
		Liquid side	(mm)	6.4	9.5
	Pipe branch- indoor unit	Gas side	(mm)	12.7	15.9
		Liquid side	(mm)	6.4	9.5
Sound pressure level		Cooling/Heating	(dB(A))	46/48	46/48
Sound power level		Cooling/Heating	(dB(A))	63/65	63/66

1-2. Outdoor Unit

Model		Outdoor unit	RAV-GP	561ATW*	801ATW*	
Power supply				220 - 240 V ~, 50 Hz		
Compressor	Type			Hermetic compressor		
	Motor		(kW)	1.10	2.00	
	Pole			4	6	
Refrigerant charged			(kg)	1.35	1.9	
Refrigerant control				Pulse motor valve		
Length of refrigerant pipe	Max.		(m)	50	50	
	Min.		(m)	3	3	
	Height difference	Outdoor lower		(m)	30	30
		Outdoor high		(m)	30	30
Outer dimension	Height			630	1050	
	Width			799	1010	
	Depth			299	370	
Appearance				Silky shade (Munsell 1Y8.5/0.5)		
Total weight			(kg)	45	74	
Heat exchanger				Finned tube		
Fan unit	Fan			Propeller fan		
	Standard air flow		(m ³ /min)	37.5	53	
	Motor		(W)	43	60	
Connecting pipe (Outdoor unit side)	Gas side		(mm)	12.7	15.9	
	Liquid side		(mm)	6.4	9.5	
Sound pressure level		Cooling/Heating	(dB(A))	46/48	46/48	
Sound power level		Cooling/Heating	(dB(A))	63/65	63/66	
Outside air temperature: Cooling			(°C)	-15 to 52		
Outside air temperature: Heating			(°C)	-27 to 15		

1-3. Operation Characteristic Curve

Operation characteristic curve

GP561

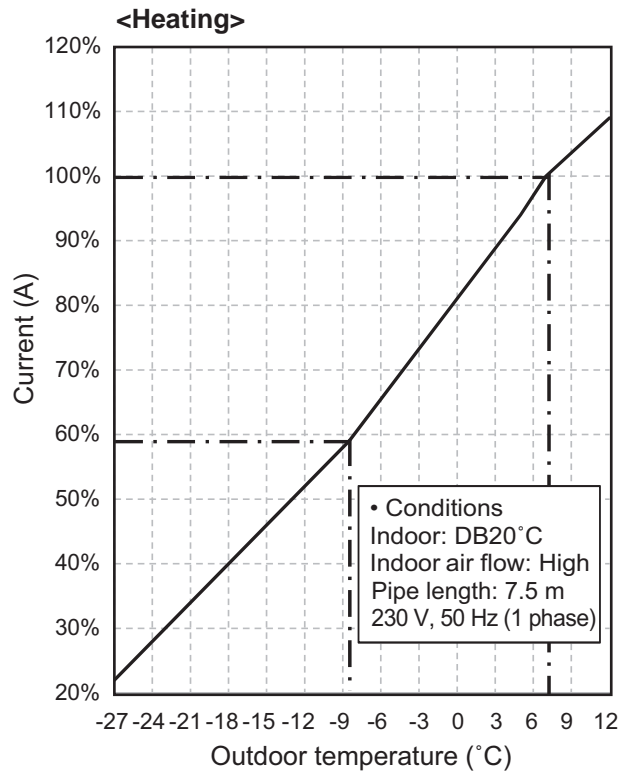
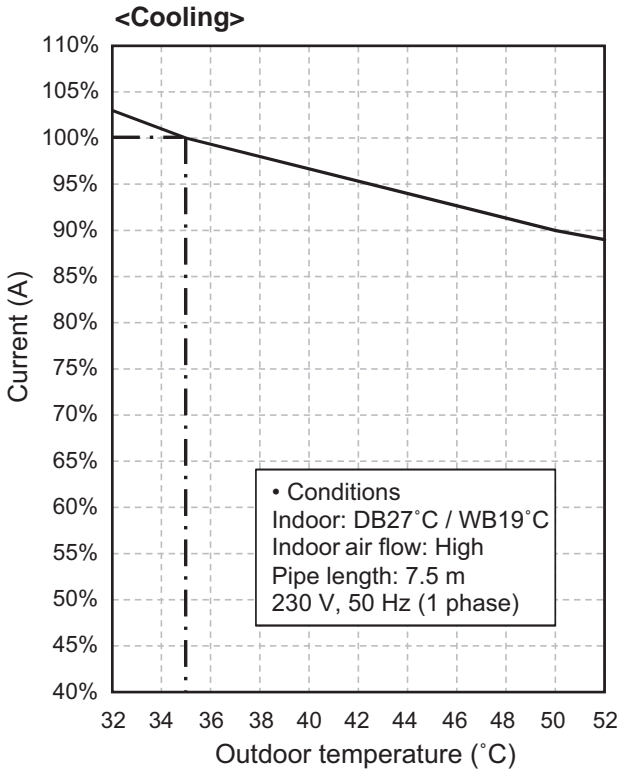

GP801

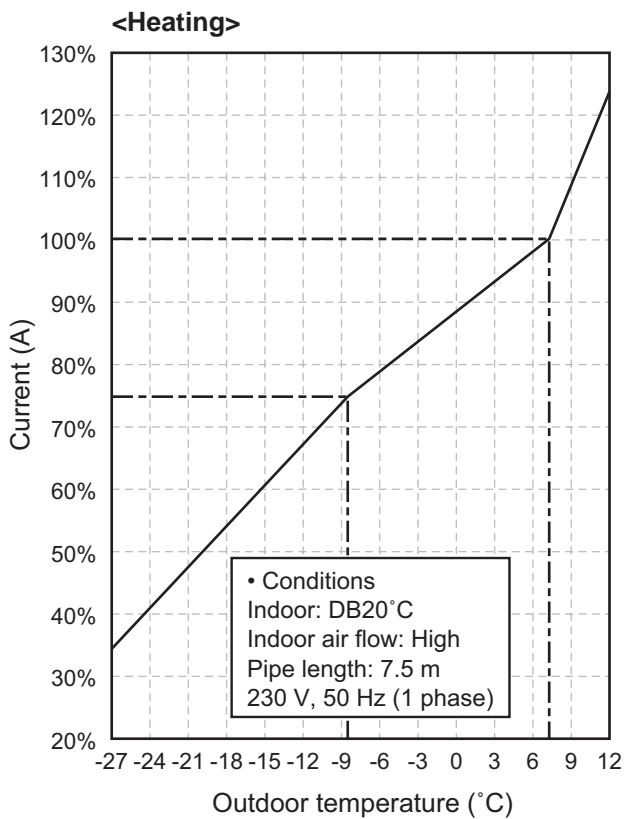
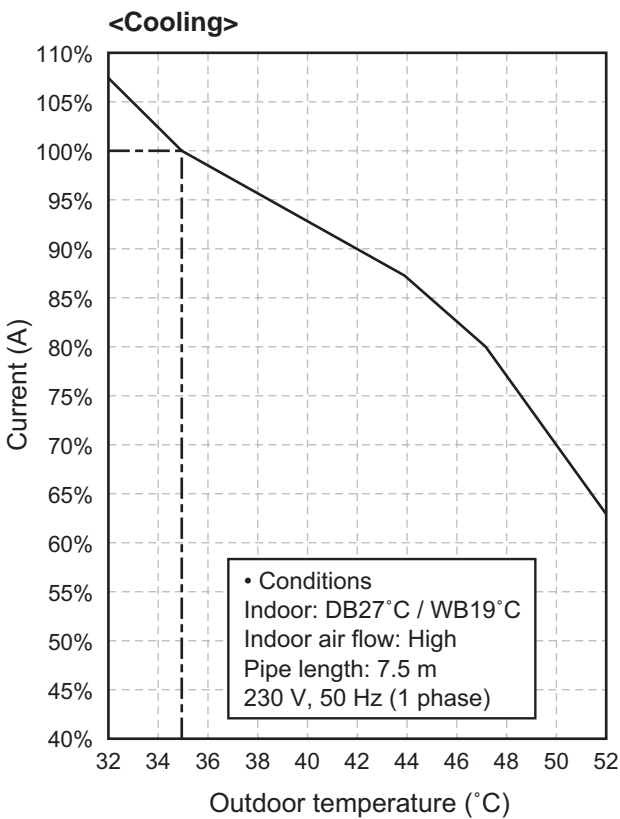

Capacity variation ratio according to temperature

GP561

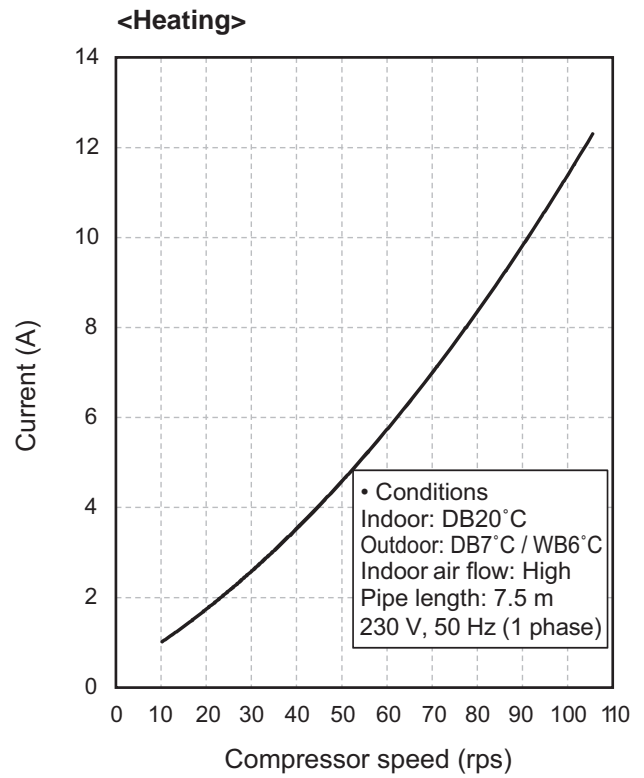
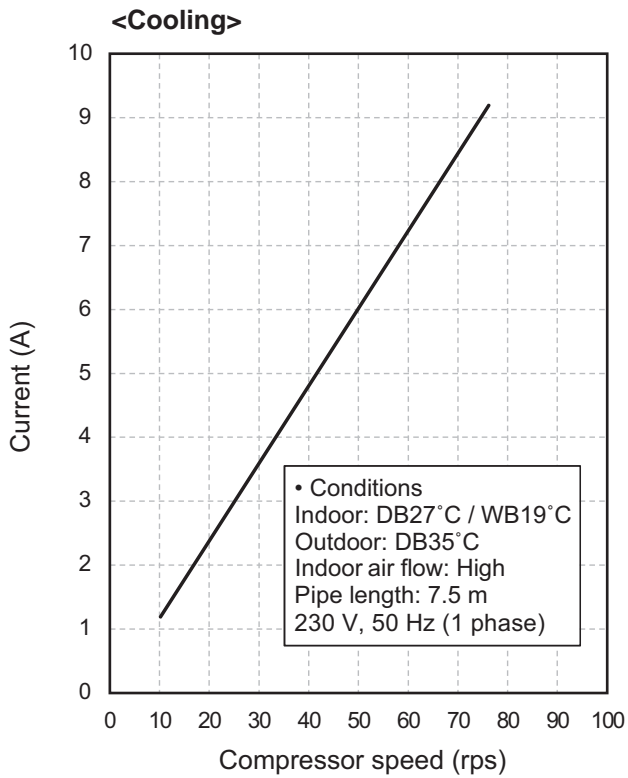

GP801

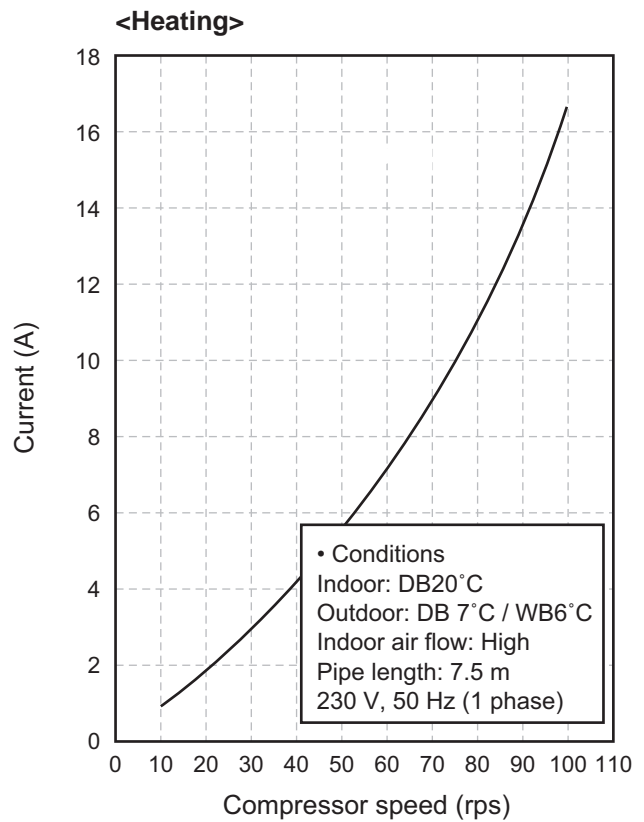
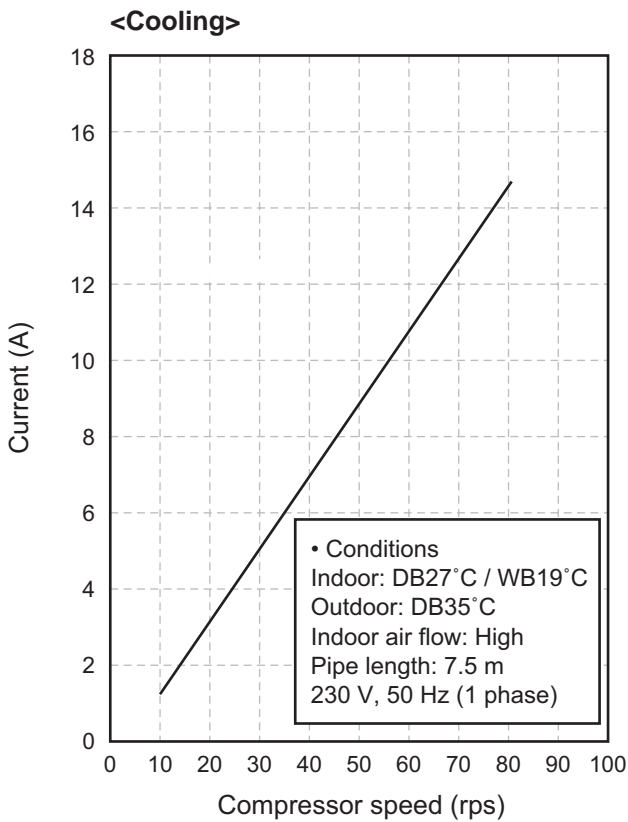

2-3. Branch pipe

RBC-TWP30E2, RBC-TWP50E2 (Simultaneous Twin)

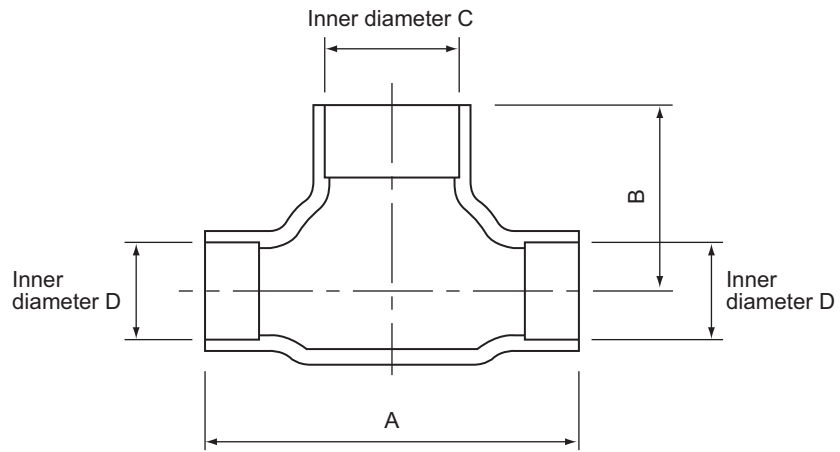

(Units: mm)

Model (RBC-)		A	B	C	D
TWP30E2	Liquid side	36	14	9.5	6.4
	Gas side	43	23	15.9	12.7
TWP50E2	Liquid side	34	14	9.5	9.5
	Gas side	44	21	15.9	15.9

3 OUTDOOR UNIT REFRIGERANTING CYCLE DIAGRAM

GP561

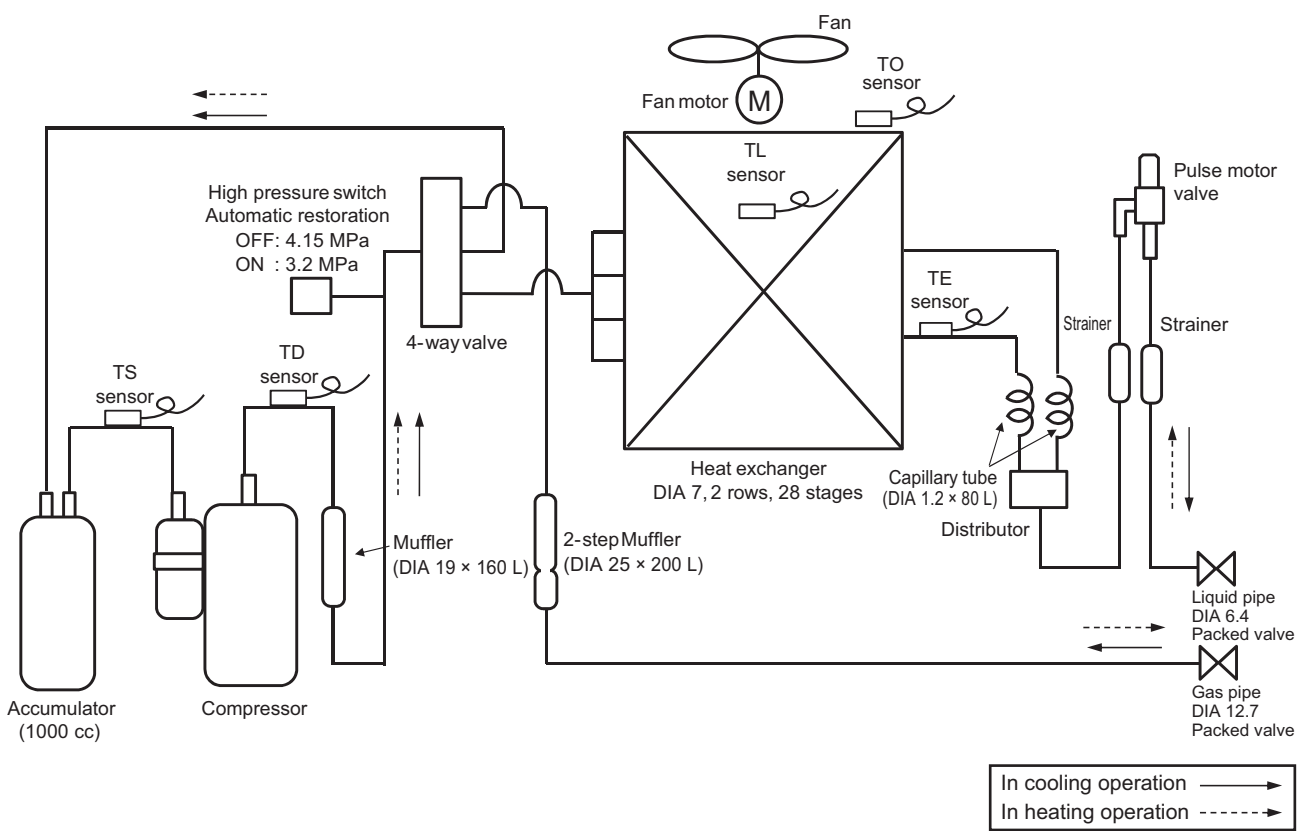

GP801

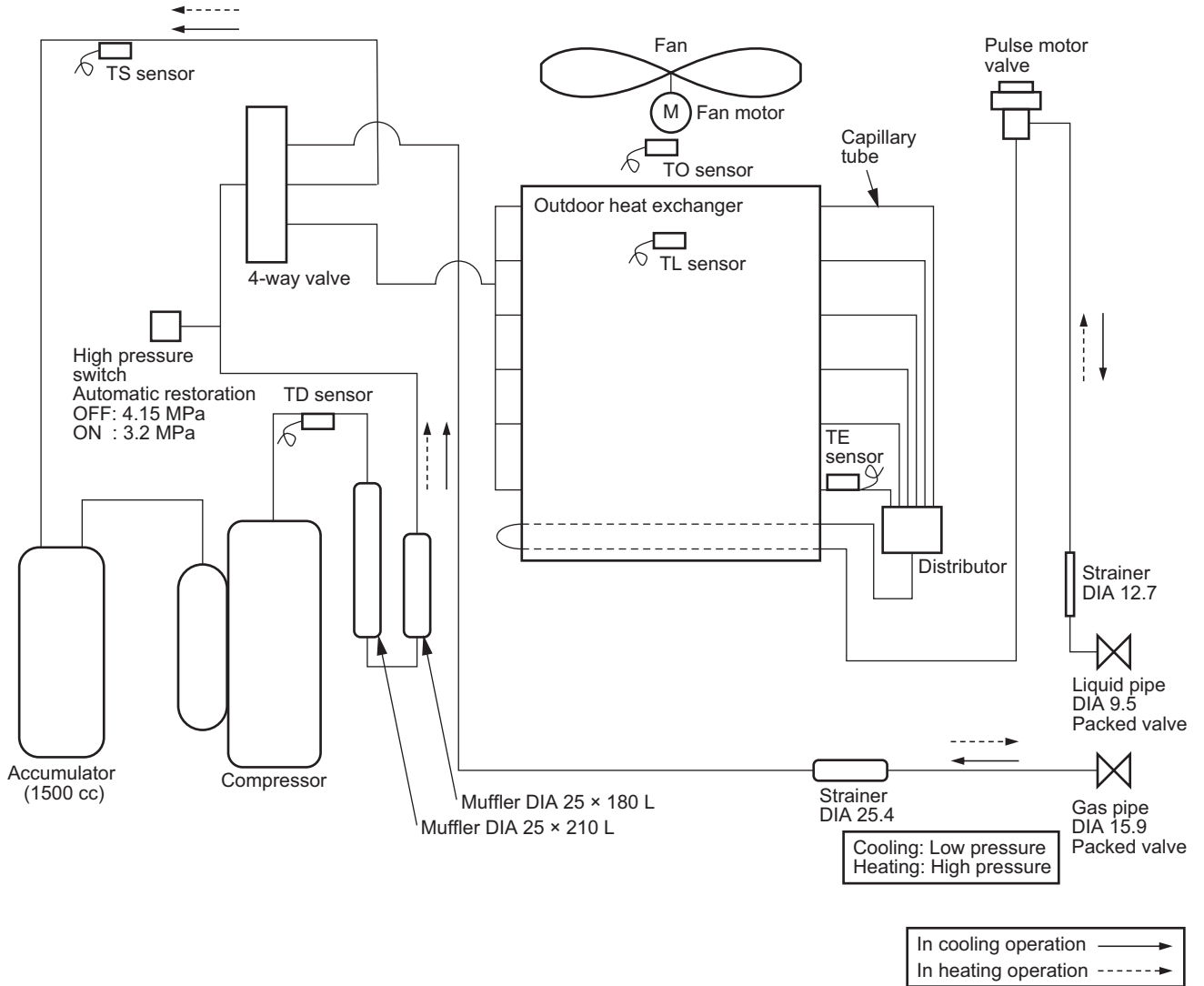

RAV-GP561 series

		Pressure				Pipe surface temperature (°C)					Compressor drive revolution frequency (rps)	Indoor fan	Indoor / Outdoor temp. conditions (DB/WB) (°C)	
		(Mpa)		(kg/cm ² g)		Discharge	Suction	Indoor heat exchanger	Outdoor heat exchanger				Indoor	Outdoor
		Pd	Ps	Pd	Ps	(TD)	(TS)	(TC)	(TL)	(TE)				
Cooling	Standard	2.8	1.0	29.0	10.6	81.0	14.0	13.0	52.0	36.0	50.0	HIGH	27/19	35/-
	Overload	3.5	1.5	35.5	15.3	75.0	24.0	23.0	56.0	55.0	25.0	HIGH	32/24	52/-
	Low load	2.4	0.8	24.6	8.2	53.0	6.0	7.0	40.0	23.0	34.0	LOW	18/15.5	-15/-
Heating	Standard	2.4	0.7	24.8	7.1	80.0	2.0	38.0	6.0	4.0	62.0	HIGH	20/-	7/6
	Overload	3.4	1.2	34.4	11.7	85.0	16.0	52.0	-17.0	17.0	44.0	LOW	30/-	24/18
	Low load	1.6	0.2	16.6	1.2	26.0	-29	25.0	-23.0	-23.0	106.0	HIGH	15/-	-27/-

* This compressor has a 4-pole motor

The value when compressor frequency (Hz) is measured by a clamp meter is 2 times the compressor revolution number (rps)

* This data is cycle data obtained by combining a 4-way cassette type.

Data will change depending on the mounted pipe length or combination with the indoor unit

RAV-GP801 series

		Pressure				Pipe surface temperature (°C)					Compressor drive revolution frequency (rps)	Indoor fan	Indoor / Outdoor temp. conditions (DB/WB) (°C)	
		(Mpa)		(kg/cm ² g)		Discharge	Suction	Indoor heat exchanger	Outdoor heat exchanger				Indoor	Outdoor
		Pd	Ps	Pd	Ps	(TD)	(TS)	(TC)	(TL)	(TE)				
Cooling	Standard	2.7	1.1	27.9	11.0	71.7	15.6	14.0	46.8	43.0	48.0	HIGH	27/19	35/-
	Overload	3.8	1.2	38.7	12.5	80.2	20.1	19.0	59.5	57.2	44.4	HIGH	32/24	52/-
	Low load	2.5	0.9	25.5	9.3	45.2	7.1	8.0	44.0	37.6	30.0	LOW	18/15.5	-15/-
Heating	Standard	2.1	0.7	21.2	7.3	66.1	4.7	32.0	9.1	3.3	60.0	HIGH	20/-	7/6
	Overload	3.6	1.2	36.9	12.7	88.7	18.2	53.0	20.0	17.4	24.0	LOW	30/-	24/18
	Low load	1.6	0.2	16.6	1.7	53.1	-26.6	22.0	-10.5	-25.7	99.6	HIGH	15/-	-27/-

* This compressor has a 6-pole motor

The value when compressor frequency (Hz) is measured by a clamp meter is 3 times the compressor revolution number (rps)

* This data is cycle data obtained by combining a 4-way cassette type.

Data will change depending on the mounted pipe length or combination with the indoor unit.

4 WIRING DIAGRAM

4-1. RAV-GP561ATW*

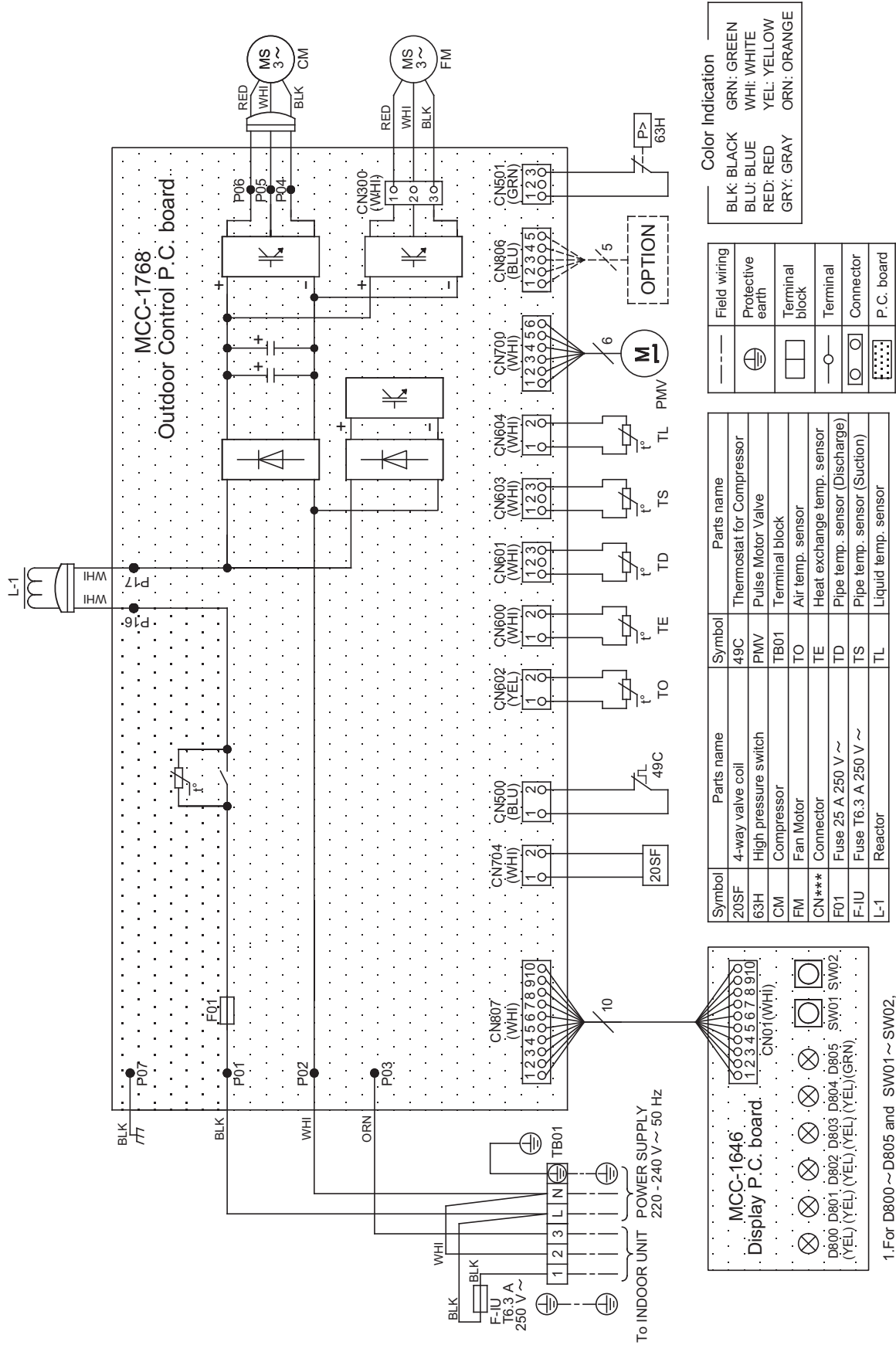

Color Indication

BLK: BLACK	GRN: GREEN
BLU: BLUE	WHI: WHITE
RED: RED	YEL: YELLOW
GRY: GRAY	ORN: ORANGE

Field wiring

Protective earth	Terminal block
Terminal	Terminal
Connector	P.C. board

Symbol	Parts name	Symbol	Parts name
20SF	4-way valve coil	49C	Thermostat for Compressor
63H	High pressure switch	PMV	Pulse Motor Valve
CM	Compressor	TB01	Terminal block
FM	Fan Motor	TO	Air temp. sensor
CN***	Connector	TE	Heat exchange temp. sensor
F01	Fuse 25 A 250 V ~	TD	Pipe temp. sensor (Discharge)
F-IU	Fuse T6.3 A 250 V ~	TS	Pipe temp. sensor (Suction)
L-1	Reactor	TL	Liquid temp. sensor

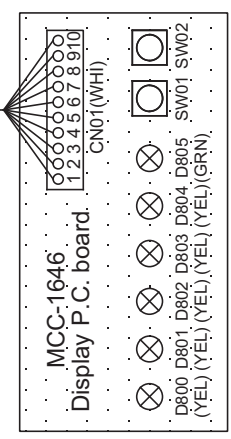

1. For D800 ~ D805 and SW01 ~ SW02, refer to the installation manual.

4-2. RAV-GP801ATW*

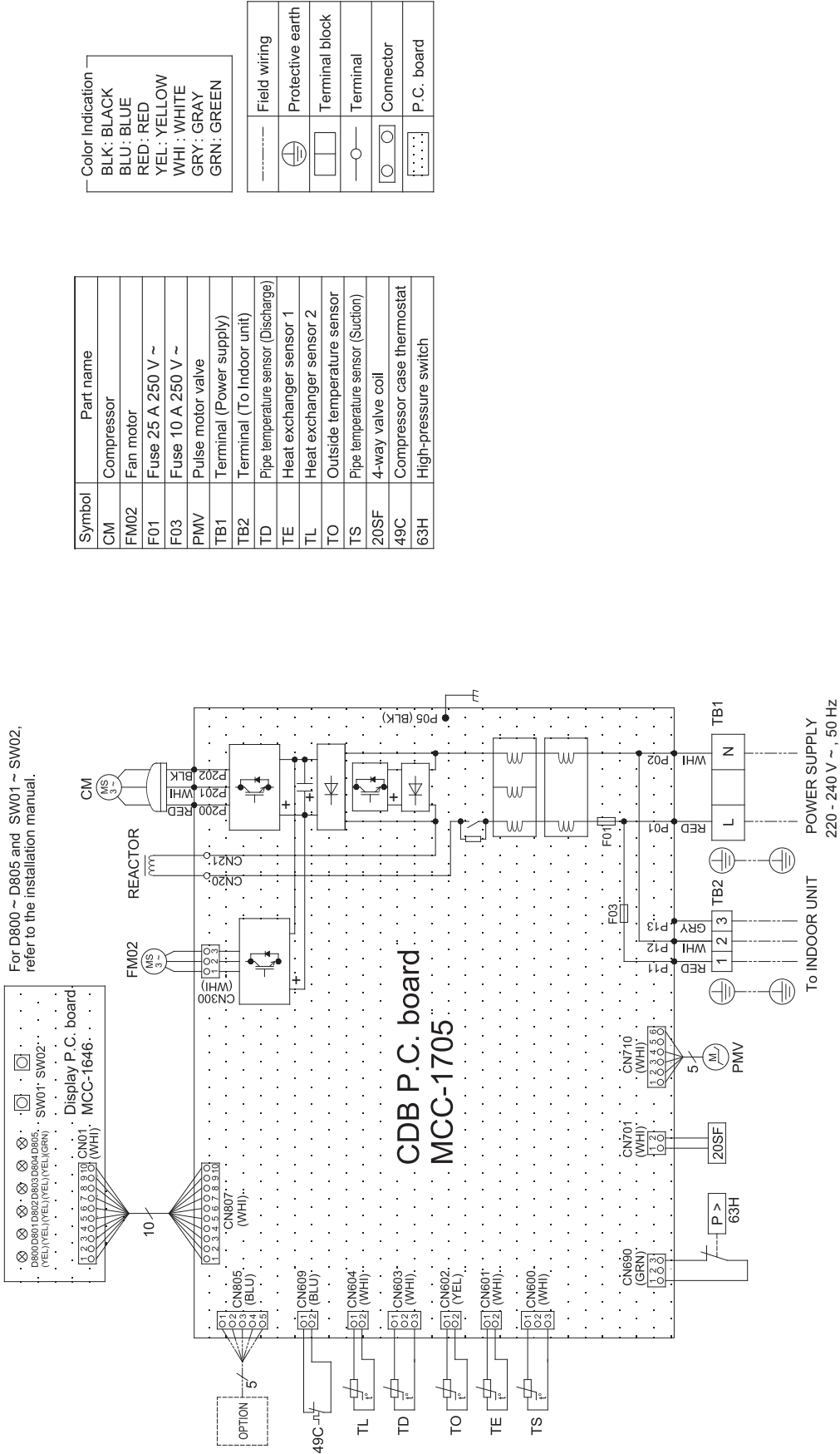

5 SPECIFICATIONS OF ELECTRICAL PARTS

5-1. Outdoor Unit

RAV-GP561ATW*

No.	Parts name	Type	Specifications
1	Compressor	DX150A1T-21F	—
2	Outdoor fan motor	ICF-140-A43-1	DC140 V, 43 W
3	4-way valve coil	STF-H01AZ1724A1	DC12 V
4	PMV coil	PQ-M10012-000313	DC12 V
5	High pressure switch	ACB-4UB154W	OFF: 4.15 Mpa
6	Compressor thermostat (Protection)	CS-12AL	OFF: 125 ± 4°C, ON: 90 ± 5°C
7	Reactor	CH-102-Z-T	18 mH, 16 A
8	P.C. board	MCC-1768	—
9	Outdoor temp. sensor (TO sensor)	—	10 kΩ at 25°C
10	Discharge temp. sensor (TD sensor)	—	1.905 kΩ at 120°C
11	Suction temp. sensor (TS sensor)	—	10 kΩ at 25°C
12	Heat exchanger temp. sensor (TE sensor)	—	10 kΩ at 25°C
13	Heat exchanger mid. temp. sensor (TL sensor)	—	3.3 kΩ at 100°C
14	Fuse (Inverter, input (Current protect))	—	25 A, AC 250 V
15	Fuse (Switching power (Protect))	—	3.15 A, AC 250 V
16	Fuse (Indoor unit, input (Current protect))	—	6.3 A, AC 250 V

RAV-GP801ATW*

No.	Parts name	Type	Specifications
1	Compressor	NX220A1F-20N	—
2	Outdoor fan motor	ICF-280-A60-1	DC280 V, 60 W
3	4-way valve coil	STF-H01AZ1724A1	DC12 V
4	PMV coil	UKV-A040	DC12 V
5	High pressure switch	ACB-4UB83W	OFF: 4.15 MPa
6	Compressor thermostat	US-622	OFF: 125 ± 4°C, ON: 90 ± 5°C
7	Reactor	CH-101	10 mH, 20 A
8	P.C. board	MCC-1705	—
9	P.C. board (LED display)	MCC-1646	—
10	Outdoor temp. sensor (TO sensor)	—	10 kΩ at 25°C
11	Discharge temp. sensor (TD sensor)	—	1.905 kΩ at 120°C
12	Suction temp. sensor (TS sensor)	—	10 kΩ at 25°C
13	Heat exchanger temp. sensor (TE sensor)	—	10 kΩ at 25°C
14	Heat exchanger mid. temp. sensor (TL sensor)	—	1.905 kΩ at 120°C
15	Fuse (Mounted on P.C. board, MCC-1705)	GDT250V25A-A	25 A, 250 V
16	Fuse (Mounted on P.C. board, MCC-1705)	—	3.15 A, 250 V
17	Fuse (Mounted on P.C. board, MCC-1705)	—	10 A, 250 V
18	Relay	—	20 A, 250 V

5-2. Winding resistance of outdoor unit main parts

No.	Parts name	Checking procedure							
1	Compressor (Model: DX150A1T-21F)	<p>Measure and compare each winding resistance by digital tester.</p> <table border="1"> <thead> <tr> <th>Position</th> <th>Resistance value</th> </tr> </thead> <tbody> <tr> <td>Red - White</td> <td rowspan="3">1.10 Ω \pm 0.055</td> </tr> <tr> <td>White - Black</td> </tr> <tr> <td>Black - Red</td> </tr> </tbody> </table> <p>(all same resistance is ok.) at 20°C</p>	Position	Resistance value	Red - White	1.10 Ω \pm 0.055	White - Black	Black - Red	
Position	Resistance value								
Red - White	1.10 Ω \pm 0.055								
White - Black									
Black - Red									
2	Compressor (Model: NX220A1F-20N)	<p>Measure and compare each winding resistance by digital tester.</p> <table border="1"> <thead> <tr> <th>Position</th> <th>Resistance value</th> </tr> </thead> <tbody> <tr> <td>Red - White</td> <td rowspan="3">1.22 Ω \pm 0.06</td> </tr> <tr> <td>White - Black</td> </tr> <tr> <td>Black - Red</td> </tr> </tbody> </table> <p>(all same resistance is ok.) at 20°C</p>	Position	Resistance value	Red - White	1.22 Ω \pm 0.06	White - Black	Black - Red	
Position	Resistance value								
Red - White	1.22 Ω \pm 0.06								
White - Black									
Black - Red									
3	Fan motor (Model: ICF-140-A43-1)	<p>Measure and compare each winding resistance by digital tester.</p> <table border="1"> <thead> <tr> <th>Position</th> <th>Resistance value</th> </tr> </thead> <tbody> <tr> <td>Red - White</td> <td rowspan="3">21.00 Ω \pm 1.05</td> </tr> <tr> <td>White - Black</td> </tr> <tr> <td>Black - Red</td> </tr> </tbody> </table> <p>(all same resistance is ok.) at 20°C</p>	Position	Resistance value	Red - White	21.00 Ω \pm 1.05	White - Black	Black - Red	
Position	Resistance value								
Red - White	21.00 Ω \pm 1.05								
White - Black									
Black - Red									
4	Fan motor (Model: ICF-280-A60-1)	<p>Measure and compare each winding resistance by digital tester.</p> <table border="1"> <thead> <tr> <th>Position</th> <th>Resistance value</th> </tr> </thead> <tbody> <tr> <td>Red - White</td> <td rowspan="3">32.6 Ω \pm 3.3</td> </tr> <tr> <td>White - Black</td> </tr> <tr> <td>Black - Red</td> </tr> </tbody> </table> <p>(all same resistance is ok.) at 20°C</p>	Position	Resistance value	Red - White	32.6 Ω \pm 3.3	White - Black	Black - Red	
Position	Resistance value								
Red - White	32.6 Ω \pm 3.3								
White - Black									
Black - Red									
5	4-way valve coil (Model: STF-H01AZ1724A1)	<p>Measure each winding resistance by digital tester.</p> <table border="1"> <thead> <tr> <th>Resistance value</th> </tr> </thead> <tbody> <tr> <td>7.1 Ω \pm 0.36</td> </tr> </tbody> </table> <p>at 20°C</p>	Resistance value	7.1 Ω \pm 0.36					
Resistance value									
7.1 Ω \pm 0.36									
6	PMV (Pulse Motor Vale) coil (Model: PQ-M10012-000313)	<p>Measure each winding resistance by digital tester.</p> <table border="1"> <thead> <tr> <th>Position</th> <th>Resistance value</th> </tr> </thead> <tbody> <tr> <td>White - Red (COM)</td> <td rowspan="4">46 Ω \pm 3.7</td> </tr> <tr> <td>Orange - Red (COM)</td> </tr> <tr> <td>Yellow - Gray (COM)</td> </tr> <tr> <td>Blue - Gray (COM)</td> </tr> </tbody> </table> <p>at 20°C</p>	Position	Resistance value	White - Red (COM)	46 Ω \pm 3.7	Orange - Red (COM)	Yellow - Gray (COM)	Blue - Gray (COM)
Position	Resistance value								
White - Red (COM)	46 Ω \pm 3.7								
Orange - Red (COM)									
Yellow - Gray (COM)									
Blue - Gray (COM)									
7	PMV (Pulse Motor Vale) coil (Model: UKV-A040)	<p>Measure each winding resistance by digital tester.</p> <table border="1"> <thead> <tr> <th>Position</th> <th>Resistance value</th> </tr> </thead> <tbody> <tr> <td>Black - Gray (COM)</td> <td rowspan="4">46 Ω \pm 3</td> </tr> <tr> <td>Yellow - Gray (COM)</td> </tr> <tr> <td>Red - Gray (COM)</td> </tr> <tr> <td>Orange - Gray (COM)</td> </tr> </tbody> </table> <p>at 20°C</p>	Position	Resistance value	Black - Gray (COM)	46 Ω \pm 3	Yellow - Gray (COM)	Red - Gray (COM)	Orange - Gray (COM)
Position	Resistance value								
Black - Gray (COM)	46 Ω \pm 3								
Yellow - Gray (COM)									
Red - Gray (COM)									
Orange - Gray (COM)									

6 REFRIGERANT R32

This air conditioner adopts the R32 refrigerant which does not damage the ozone layer.

The working pressure of the new refrigerant R32 is 1.6 times higher than conventional refrigerant (R22).

The refrigerating oil is also changed in accordance with change of refrigerant, so be careful that water, dust, and existing refrigerant or refrigerating oil are not entered in the refrigerant cycle of the air conditioner using the new refrigerant during installation work or servicing time.

The next section describes the precautions for air conditioner using the new refrigerant.

Conforming to contents of the next section together with the general cautions included in this manual, perform the correct and safe work.

6-1. Safety During Installation / Servicing

As R32's pressure is about 1.6 times higher than that of R22, improper installation / servicing may cause a serious trouble. By using tools and materials exclusive for R32, it is necessary to carry out installation / servicing safely while taking the following precautions into consideration.

- (1) Never use refrigerant other than R32 in an air conditioner which is designed to operate with R32. If other refrigerant than R32 is mixed, pressure in the refrigeration cycle becomes abnormally high, and it may cause personal injury, etc. by a rupture.
- (2) Confirm the used refrigerant name, and use tools and materials exclusive for the refrigerant R32. The refrigerant name R32 is indicated on the visible place of the outdoor unit of the air conditioner using R32 as refrigerant. A diameter of the charge port for R32 is the same as that for the R410A's. Be careful not to charge the refrigerant by mistake.
- (3) If a refrigeration gas leakage occurs during installation / servicing, be sure to ventilate fully. If the refrigerant gas comes into contact with fire, a poisonous gas may occur.
- (4) When installing or removing an air conditioner, do not allow air or moisture to remain in the refrigeration cycle. Otherwise, pressure in the refrigeration cycle may become abnormally high so that a rupture or personal injury may be caused.
- (5) After completion of installation work, check to make sure that there is no refrigeration gas leakage. If the refrigerant gas leaks into the room, coming into contact with fire in the fan-driven heater, space heater, etc., a poisonous gas may occur.

- (6) When an air conditioning system charged with a large volume of refrigerant is installed in a small room, it is necessary to exercise care so that, even when refrigerant leaks, its concentration does not exceed the marginal level. If the refrigerant gas leakage occurs and its concentration exceeds the marginal level, an oxygen starvation accident may result.
- (7) Be sure to carry out installation or removal according to the installation manual. Improper installation may cause refrigeration trouble, water leakage, electric shock, fire, etc.
- (8) Unauthorized modifications to the air conditioner may be dangerous. If a breakdown occurs please call a qualified air conditioner technician or electrician. Improper repair may result in water leakage, electric shock and fire, etc.

6-2. Refrigerant Piping Installation

6-2-1. Piping Materials and Joints Used

For the refrigerant piping installation, copper pipes and joints are mainly used.

Copper pipes and joints suitable for the refrigerant must be chosen and installed.

Furthermore, it is necessary to use clean copper pipes and joints whose interior surfaces are less affected by contaminants.

(1) Copper Pipes

It is necessary to use seamless copper pipes which are made of either copper or copper alloy and it is desirable that the amount of residual oil is less than 40 mg / 10 m.

Do not use copper pipes having a collapsed, deformed or discolored portion (especially on the interior surface).

Otherwise, the expansion valve or capillary tube may become blocked with contaminants.

As an air conditioner using R32 incurs pressure higher than when using R22, it is necessary to choose adequate materials.

Thicknesses of copper pipes used with R32 are as shown in Table 6-2-1. Never use copper pipes thinner than 0.8 mm even when it is available on the market.

NOTE

Refer to the "6-6. Instructions for Re-use Piping of R22 or R407C".

Table 6-2-1 Thicknesses of annealed copper pipes

Nominal diameter	Outer diameter (mm)	Thickness (mm)	
		R410A or R32	R22
1/4	6.4	0.80	0.80
3/8	9.5	0.80	0.80
1/2	12.7	0.80	0.80
5/8	15.9	1.00	1.00

(2) Joints

For copper pipes, flare joints or socket joints are used. Prior to use, be sure to remove all contaminants.

(a) Flare Joints

Flare joints used to connect the copper pipes cannot be used for piping whose outer diameter exceeds 20 mm. In such a case, socket joints can be used.

Sizes of flare pipe ends, flare joint ends and flare nuts are as shown in Table 6-2-3 to Table 6-2-5 below.

(b) Socket Joints

Socket joints are such that they are brazed for connections, and used mainly for thick piping whose diameter is larger than 20 mm. Thicknesses of socket joints are as shown in Table 6-2-2.

Table 6-2-2 Minimum thicknesses of socket joints

Nominal diameter	Reference outer diameter of copper pipe jointed (mm)	Minimum joint thickness (mm)
1/4	6.4	0.50
3/8	9.5	0.60
1/2	12.7	0.70
5/8	15.9	0.80

6-2-2. Processing of Piping Materials

When performing the refrigerant piping installation, care should be taken to ensure that water or dust does not enter the pipe interior, that no other oil other than lubricating oils used in the installed air conditioner is used, and that refrigerant does not leak.

When using lubricating oils in the piping processing, use such lubricating oils whose water content has been removed. When stored, be sure to seal the container with an airtight cap or any other cover.

(1) Flare Processing Procedures and Precautions

(a) Cutting the Pipe

By means of a pipe cutter, slowly cut the pipe so that it is not deformed.

(b) Removing Burrs and Chips

If the flared section has chips or burrs, refrigerant leakage may occur.

Carefully remove all burrs and clean the cut surface before installation.

(c) Insertion of Flare Nut

(d) Flare Processing

Make certain that a clamp bar and copper pipe have been cleaned.

By means of the clamp bar, perform the flare processing correctly.

Use either a flare tool for R410A / R32 or conventional flare tool.

Flare processing dimensions differ according to the type of flare tool.

When using a conventional flare tool, be sure to secure "dimension A" by using a gauge for size adjustment.

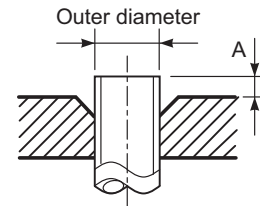

Fig. 6-2-1 Flare processing dimensions

Table 6-2-3 Dimensions related to flare processing for R410A or R32 / R22

Nominal diameter	Outer diameter (mm)	Thickness (mm)	A (mm)				
			Flare tool for R410A, R22 clutch type	Conventional flare tool (R410A or R32)		Conventional flare tool (R22)	
				Clutch type	Wing nut type	Clutch type	Wing nut type
1/4	6.4	0.8	0 to 0.5	1.0 to 1.5	1.5 to 2.0	0.5 to 1.0	1.0 to 1.5
3/8	9.5	0.8	0 to 0.5	1.0 to 1.5	1.5 to 2.0	0.5 to 1.0	1.0 to 1.5
1/2	12.7	0.8	0 to 0.5	1.0 to 1.5	2.0 to 2.5	0.5 to 1.0	1.5 to 2.0
5/8	15.9	1.0	0 to 0.5	1.0 to 1.5	2.0 to 2.5	0.5 to 1.0	1.5 to 2.0
3/4	19.1	1.2	0 to 0.5	1.0 to 1.5	2.0 to 2.5	-	-

Table 6-2-4 Flare and flare nut dimensions for R410A or R32

Nominal diameter	Outer diameter (mm)	Thickness (mm)	Dimension (mm)				Flare nut width (mm)
			A	B	C	D	
1/4	6.4	0.8	9.1	9.2	6.5	13	17
3/8	9.5	0.8	13.2	13.5	9.7	20	22
1/2	12.7	0.8	16.6	16.0	12.9	23	26
5/8	15.9	1.0	19.7	19.0	16.0	25	29
3/4	19.1	1.2	24.0	-	19.2	28	36

Table 6-2-5 Flare and flare nut dimensions for R22

Nominal diameter	Outer diameter (mm)	Thickness (mm)	Dimension (mm)				Flare nut width (mm)
			A	B	C	D	
1/4	6.4	0.8	9.1	9.2	6.5	13	17
3/8	9.5	0.8	13.0	13.5	9.7	20	22
1/2	12.7	0.8	16.2	16.0	12.9	20	24
5/8	15.9	1.0	19.4	19.0	16.0	23	27
3/4	19.1	1.0	23.3	24.0	19.2	34	36

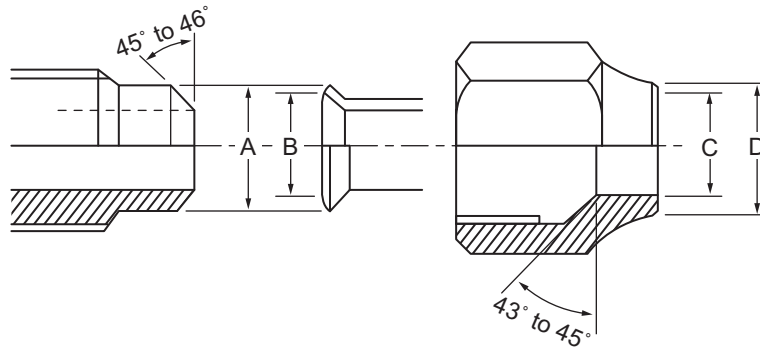

Fig. 6-2-2 Relations between flare nut and flare seal surface

(2) Flare Connecting Procedures and Precautions

- Make sure that the flare and union portions do not have any scar or dust, etc.
- Correctly align the processed flare surface with the union axis.
- Tighten the flare with designated torque by means of a torque wrench.

The tightening torque for R410A or R32 is the same as that for conventional R22.

Incidentally, when the torque is weak, the gas leakage may occur.

When it is strong, the flare nut may crack and may be made non-removable.

When choosing the tightening torque, comply with values designated by manufacturers.

Table 6-2-6 shows reference values.

NOTE

When applying oil to the flare surface, be sure to use oil designated by the manufacturer.

If any other oil is used, the lubricating oils may deteriorate and cause the compressor to burn out.

Table 6-2-6 Tightening torque of flare for R410A or R32 [Reference values]

Nominal diameter	Outer diameter (mm)	Tightening torque N·m (kgf·m)	Tightening torque of torque wrenches available on the market N·m (kgf·m)
1/4	6.4	14 to 18 (1.4 to 1.8)	16 (1.6), 18 (1.8)
3/8	9.5	33 to 42 (3.3 to 4.2)	42 (4.2)
1/2	12.7	50 to 62 (5.0 to 6.2)	55 (5.5)
5/8	15.9	68 to 82 (6.8 to 8.2)	65 (6.5)
3/4	19.1	100 to 120 (10.0 to 12.0)	-

6-3. Tools

6-3-1. Required Tools

Refer to the “(4) Tools” (Page 17)

6-4. Recharging of Refrigerant

When it is necessary to recharge refrigerant, charge the specified amount of new refrigerant according to the following steps.

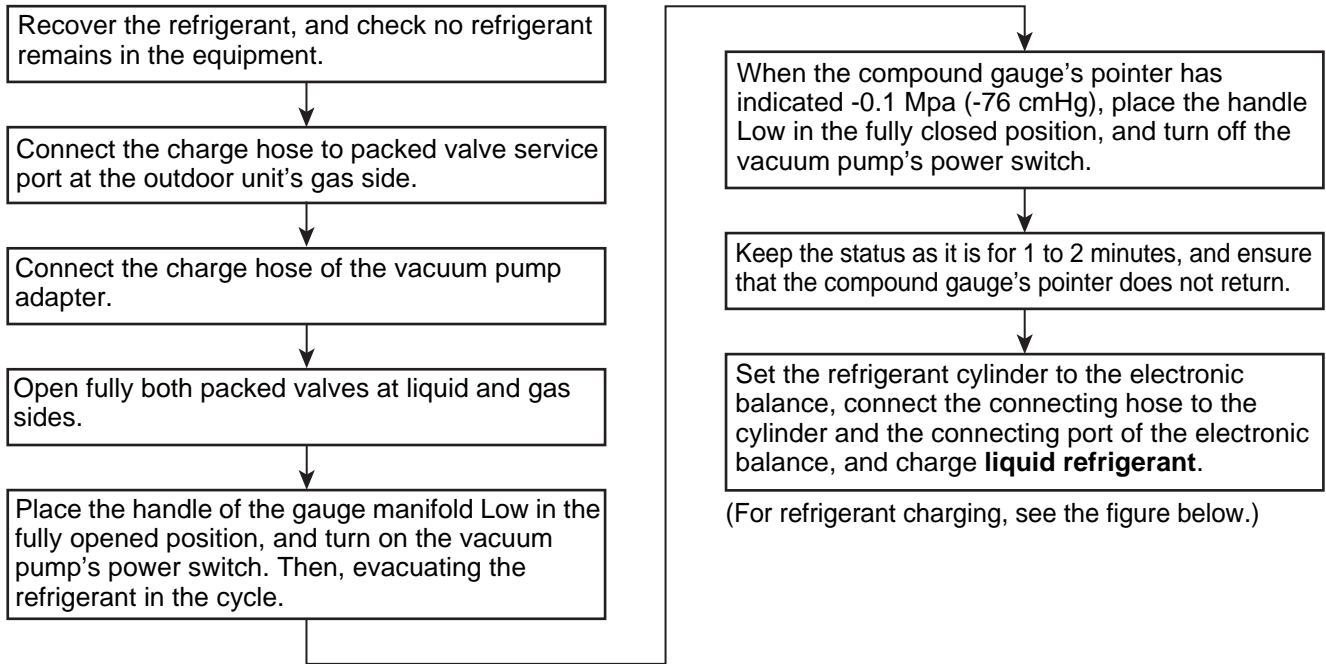

NOTE

- (1) Never charge refrigerant exceeding the specified amount.
- (2) If the specified amount of refrigerant cannot be charged, charge refrigerant **bit by bit** in COOL mode.
- (3) Do not carry out additional charging.
When additional charging is carried out if refrigerant leaks, the refrigerant composition changes in the refrigeration cycle, which changes characteristics of the air conditioner, refrigerant exceeding the specified amount is charged, and working pressure in the refrigeration cycle becomes abnormally high pressure, and may cause a rupture or personal injury.

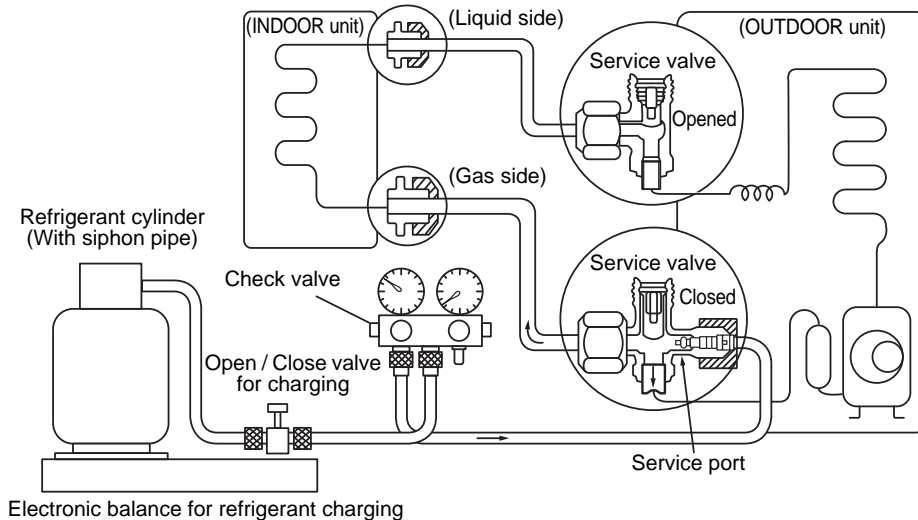

Fig. 6-4-1 Configuration of refrigerant charging

NOTE

- (1) Be sure to make setting so that **liquid** can be charged.
- (2) When using a cylinder equipped with a siphon, liquid can be charged without turning it upside down.

R32 refrigerant is a Single-component refrigerant that does not change its composition.

Although it is possible to charge the refrigerant with either liquid or gas, charge it with liquid.

(If using gas for charging, composition of the refrigerant changes and then characteristics of the air conditioner change.)

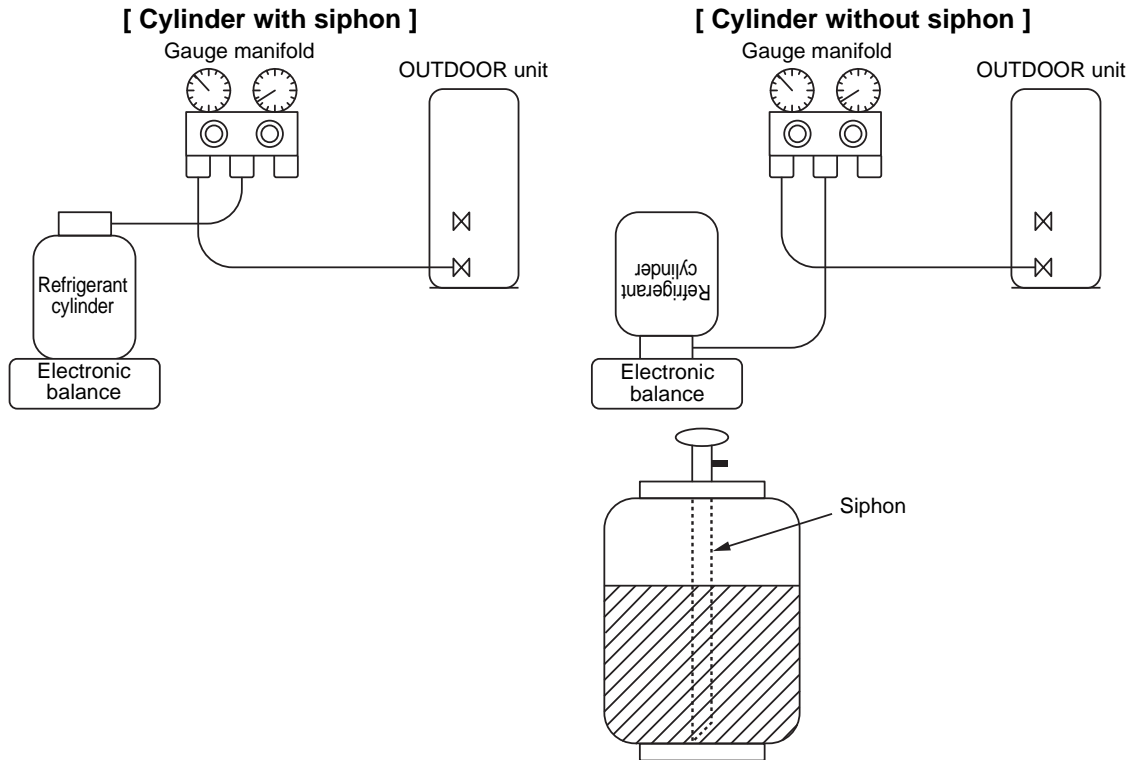

Fig. 6-4-2

6-5. Brazing of Pipes

6-5-1. Materials for Brazing

(1) Silver brazing filler

Silver brazing filler is an alloy mainly composed of silver and copper.

It is used to join iron, copper or copper alloy, and is relatively expensive though it excels in solderability.

(2) Phosphor bronze brazing filler

Phosphor bronze brazing filler is generally used to join copper or copper alloy.

(3) Low temperature brazing filler

Low temperature brazing filler is generally called solder, and is an alloy of tin and lead.

Since it is weak in adhesive strength, do not use it for refrigerant pipes.

NOTE

- (1) Phosphor bronze brazing filler tends to react with sulfur and produce a fragile compound water solution, which may cause a gas leakage. Therefore, use any other type of brazing filler at a hot spring resort, etc., and coat the surface with a paint.
- (2) When performing brazing again at time of servicing, use the same type of brazing filler.

6-5-2. Flux

(1) Reason why flux is necessary

- By removing the oxide film and any foreign matter on the metal surface, it assists the flow of brazing filler.
- In the brazing process, it prevents the metal surface from being oxidized.
- By reducing the brazing filler's surface tension, the brazing filler adheres better to the treated metal.

(2) Characteristics required for flux

- Activated temperature of flux coincides with the brazing temperature.
- Due to a wide effective temperature range, flux is hard to carbonize.
- It is easy to remove slag after brazing.
- The corrosive action to the treated metal and brazing filler is minimum.
- It excels in coating performance and is harmless to the human body.

As the flux works in a complicated manner as described above, it is necessary to select an adequate type of flux according to the type and shape of treated metal, type of brazing filler and brazing method, etc.

(3) Types of flux

- **Noncorrosive flux**
Generally, it is a compound of borax and boric acid.
It is effective in case where the brazing temperature is higher than 800°C.
- **Activated flux**
Most of fluxes generally used for silver brazing are this type.
It features an increased oxide film removing capability due to the addition of compounds such as potassium fluoride, potassium chloride and sodium fluoride to the borax-boric acid compound.

(4) Piping materials for brazing and used brazing filler / flux

Piping material	Used brazing filler	Used flux
Copper - Copper	Phosphor copper	Do not use
Copper - Iron	Silver	Paste flux
Iron - Iron	Silver	Vapor flux

NOTE

- (1) Do not enter flux into the refrigeration cycle.
- (2) When chlorine contained in the flux remains within the pipe, the lubricating oil deteriorates. Therefore, use a flux which does not contain chlorine.
- (3) When adding water to the flux, use water which does not contain chlorine (e.g. distilled water or ion-exchange water).
- (4) Remove the flux after brazing.

6-5-3. Brazing

As brazing work requires sophisticated techniques, experiences based upon a theoretical knowledge, it must be performed by a person qualified. In order to prevent the oxide film from occurring in the pipe interior during brazing, it is effective to proceed with brazing while letting dry Nitrogen gas flow.

Never use gas other than Nitrogen gas.

(1) Brazing method to prevent oxidation

- (1) Attach a reducing valve and a flow-meter to the Nitrogen gas cylinder.
- (2) Use a copper pipe to direct the piping material, and attach a flow-meter to the cylinder.
- (3) Apply a seal onto the clearance between the piping material and inserted copper pipe for Nitrogen in order to prevent backflow of the Nitrogen gas.
- (4) When the Nitrogen gas is flowing, be sure to keep the piping end open.
- (5) Adjust the flow rate of Nitrogen gas so that it is lower than 0.05 m³/Hr or 0.02 MPa (0.2 kgf/cm²) by means of the reducing valve.
- (6) After performing the steps above, keep the Nitrogen gas flowing until the pipe cools down to a certain extent (temperature at which pipes are touchable with hands).
- (7) Remove the flux completely after brazing.

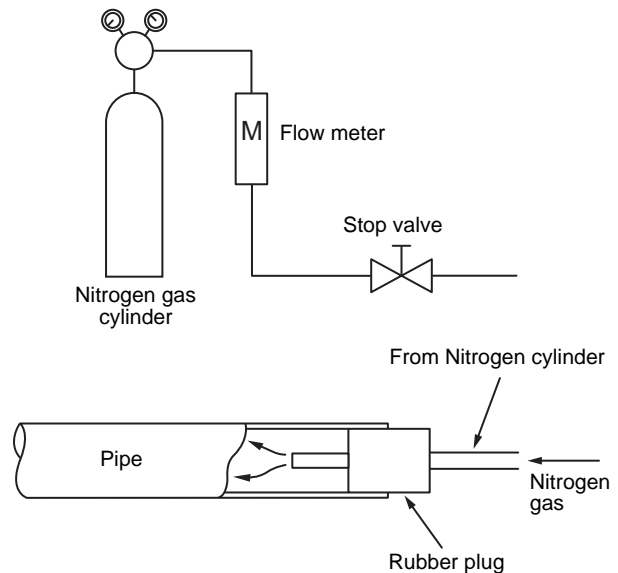

Fig. 6-5-1 Prevention of oxidation during brazing

6-6. Instructions for Re-use Piping of R22 or R407C

Instruction of Works:

The existing R22 and R407C piping can be reused for our digital inverter R32 products installations.

WARNING

Confirming the existence of scratches or dents on the existing pipes and confirming the reliability of the pipe strength are conventionally referred to the local site. If the specified conditions can be cleared, it is possible to update existing R22 and R407C pipes to those for R32 models.

6-6-1. Basic Conditions Needed to Reuse the Existing Pipe

Check and observe three conditions of the refrigerant piping works.

- (1) Dry (There is no moisture inside of the pipes.)
- (2) Clean (There is no dust inside of the pipes.)
- (3) Tight (There is no refrigerant leak.)

6-6-2. Restricted Items to Use the Existing Pipes

In the following cases, the existing pipes cannot be reused as they are. Clean the existing pipes or exchange them with new pipes.

- (1) When a scratch or dent is heavy, be sure to use the new pipes for the works.
- (2) When the thickness of the existing pipe is thinner than the specified "Pipe diameter and thickness" be sure to use the new pipes for the works.
 - The operating pressure of R32 is high. If there is a scratch or dent on the pipe or a thinner pipe is used, the pressure strength may be inadequate, which may cause the pipe to break in the worst case.

* Pipe diameter and thickness (mm)

Reference outside diameter (mm)	Wall thickness (mm)	Material
6.4	0.8	-
9.5	0.8	-
12.7	0.8	-
15.9	1.0	-

- In case that the pipe diameter is DIA 12.7 mm or less and the thickness is less than 0.7 mm, be sure to use the new pipes for works.
- (3) When the outdoor unit was left with the pipes disconnected, or the gas leaked from the pipes and the pipes were not repaired and refilled.
 - There is possibility that rain water or air including moisture enters in the pipe.
 - (4) When refrigerant cannot be recovered using a refrigerant recovery unit.
 - There is possibility that a large quantity of poor oil or moisture remains inside of the pipe.
 - (5) When a commercially available dryer is attached to the existing pipes.

- There is possibility that copper green rust generated.
- (6) When the existing air conditioner is removed after refrigerant has been recovered. Check if the oil is judged to be clearly different from normal oil like following.
 - The refrigerator oil is copper rust green: There is possibility that moisture is mixed with the oil and rust generates inside of the pipe.
 - There is discolored oil, a large quantity of the remains, or bad smell.
 - A large quantity of sparkle remained wear-out powder is observed in the refrigerator oil.
 - (7) When the air conditioner has a history of the compressor failing and being replaced.
 - When discolored oil, a large quantity of residue, of foreign matter is observed, trouble will occur.
 - (8) When temporary installation and removal of the air conditioner are repeated such as when leased, etc.
 - (9) When the type of refrigerator oil of the existing air conditioner is other than the following oil (Mineral oil) Suniso, Freol-S, MS (Synthetic oil), alkyl benzene (HAB, Barrel-freeze), ester series, PVE only of ether series.
 - The winding-insulation of the compressor may deteriorate.

NOTE

The above descriptions are results of confirmation by our company and they are views on our air conditioners, but they do not guarantee the use of the existing pipes of the air conditioner that adopted R32 or R410A in other companies.

6-6-3. Branching Pipe for Simultaneous Operation System

- In the concurrent twin system, when TOSHIBA-specified branching pipe is used, it can be reused. Branching pipe model name: RBC-TWP30E2, RBC-TWP50E2. On the existing air conditioner for simultaneous operation system (twin system), there is a case of using branch pipe that has insufficient compressive strength. In this case please change it to the branch pipe for R32 or R410A.

6-6-4. Curing of Pipes

When removing and opening the indoor unit or outdoor unit for a long time, cure the pipes as follows:

- Otherwise rust may generate when moisture or foreign matter due to dewing enters in the pipes.
- The rust cannot be removed by cleaning, and a new piping work is necessary.

Place position	Term	Curing manner
Outdoors	1 month or more	Pinching
	Less than 1 month	Pinching or taping
Indoors	Every time	

6-6-5. Final Installation Checks

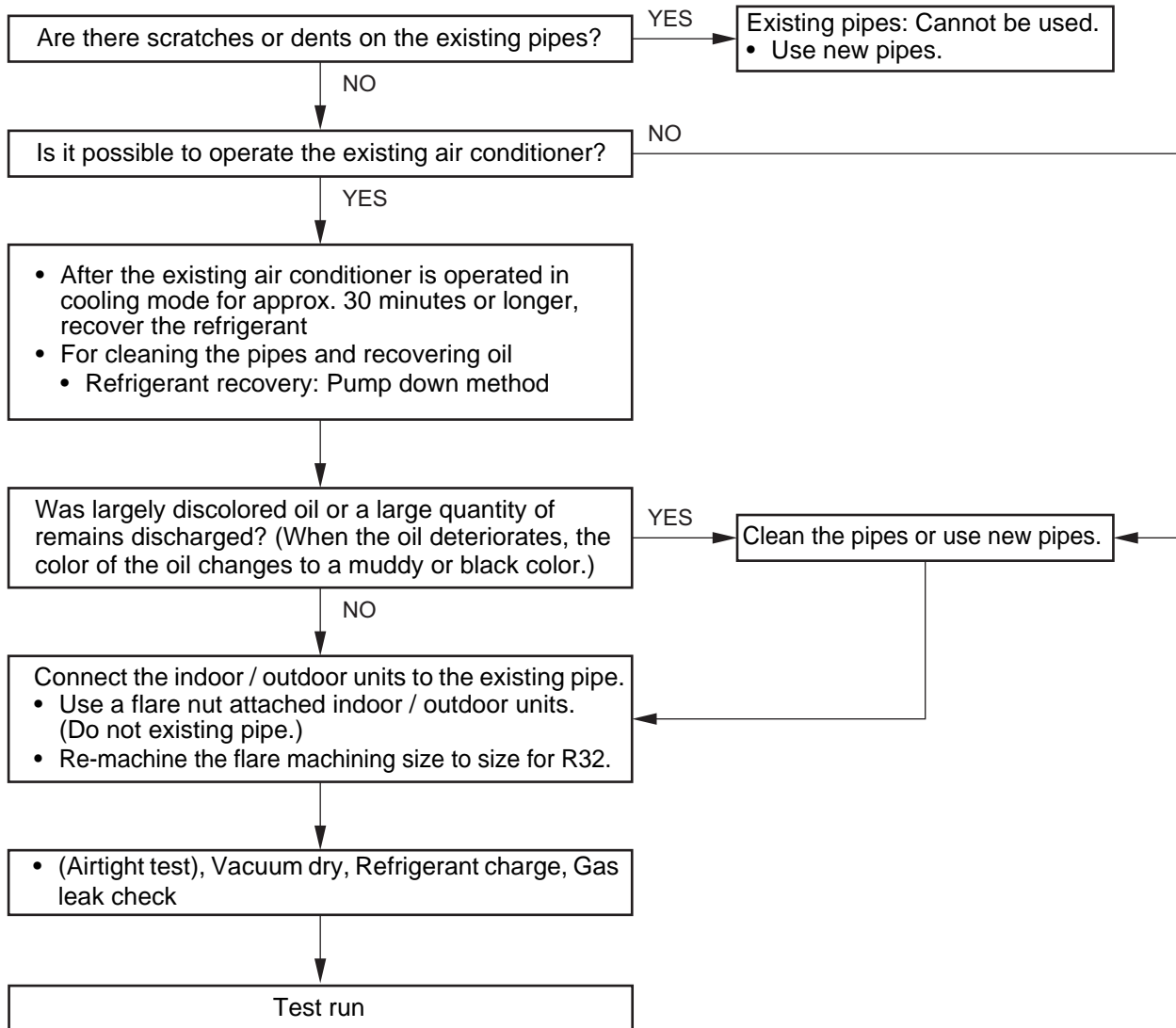

6-6-6. Handling of Existing Pipe

When using the existing pipe, carefully check it for the following:

- Wall thickness (within the specified range)
- Scratches and dents
- Water, oil, dirt, or dust in the pipe
- Flare looseness and leakage from welds
- Deterioration of copper pipe and heat insulator
- Before recovering the refrigerant in the existing system, perform a cooling operation for at least 30 minutes.

Cautions for using existing pipe

- Do not reuse a flare nut to prevent gas leaks. Replace it with the supplied flare nut and then process it to a flare.
- Blow nitrogen gas or use an appropriate means to keep the inside of the pipe clean. If discolored oil or much residue is discharged, wash the pipe.
- Check welds, if any, on the pipe for gas leaks.
- There may be a problem with the pressure resistance of the branching pipes of the existing piping. Replace them with branch pipes (sold separately).

When the pipe corresponds to any of the following, do not use it. Install a new pipe instead.

- The pipe has been opened (disconnected from indoor unit or outdoor unit) for a long period.
- The pipe has been connected to an outdoor unit that does not use refrigerant R22, R410A, R32 or R407C.
- The existing pipe must have a wall thickness equal to or larger than the following thicknesses.

Reference outside diameter (mm)	Wall thickness (mm)	Material
6.4	0.8	-
9.5	0.8	-
12.7	0.8	-
15.9	1.0	-
19.1	1.2	-
22.2	1.0	Half hard
28.6	1.0	Half hard

- Do not use any pipe with a wall thickness less than these thicknesses due to insufficient pressure capacity.

6-6-7. Recovering Refrigerant

Use the refrigerant recovery equipment to recover the refrigerant.

6-7. Charging additional refrigerant

Amount of additional refrigerant shall be restricted by the following explanation to ensure the reliability. Miss-charging leads to the abnormal high pressure in the refrigerant cycle, causing a rupture, an injury and a compressor malfunction.

6-7-1. [Assumed gas leak]

The refrigerant can be charged only when the amount of a leak such as a slow-leak found at the installation work can be ensured that it is within the additional limits shown in the following.

Recharge the refrigerant if the amount of leakage is unknown when you feel "Cooling is not working well" or "Heating is not working well".

6-7-2. [Limiting the additional charge]

- The maximum amount of additional refrigerant shall be up to 10% of the normal amount of the refrigerant. If no improvement in symptoms can be found at the above limitation, recover all gases and recharge the normal amount of refrigerant.
- If the slow leak is found at the installation work and the connection pipe length is 15 m or less, tighten the flare nut at the leak point and do not add the refrigerant.

6-7-3. [Cautions on charging additional refrigerant]

- When charging additional refrigerant, use a balance with an accuracy of more than 10 g scale. Do not use a health-meter etc.
- If the refrigerant gas leaks, find the leakage point and repair it securely. Though the refrigerant gas itself is innocuous, if it touch a fire source such as fan heater, stove or kitchen stove, noxious gas may occur.
- When charging the refrigerant, charge with liquid refrigerant. Work carefully and charge it little by little since it may be rapidly charged due to the liquid state.

6-8. General safety precautions for using R32 refrigerant

6-8-1. Recovery

- When removing refrigerant from a system, either for servicing or decommissioning, it is recommended good practice that all refrigerants are removed safely.
- When transferring refrigerant into cylinders, ensure that only appropriate refrigerant recovery cylinders are employed.
- Ensure that the correct number of cylinders for holding the total system charge are available.
- All cylinders to be used are designated for the recovered refrigerant and labelled for that refrigerant (i.e. special cylinders for the recovery of refrigerant).
- Cylinders shall be complete with pressure relief valve and associated shut-off valves in good working order.
- Empty recovery cylinders are evacuated and, if possible, cooled before recovery occurs.
- The recovery equipment shall be in good working order with a set of instructions concerning the equipment that is at hand and shall be suitable for the recovery of mildly flammable refrigerants.
- In addition, a set of calibrated weighing scales shall be available and in good working order.
- Hoses shall be complete with leak-free disconnect couplings and in good condition.
- Before using recovery machine check that it is satisfactory working order, has been properly maintained and that any associated electrical components are sealed to prevent ignition in the event of a refrigerant release.
- Consult manufacturer if in doubt.
- The recovered refrigerant shall be returned to the refrigerant supplier in the correct recovery cylinder, and the relevant Waste Transfer Note arranged.
- Do not mix refrigerants in recovery units and especially not in cylinders.
- If compressors or compressor oils are to be removed, ensure that they have been evacuated to an acceptable level to make certain that mildly flammable refrigerant does not remain within the lubricant.
- The evacuation process shall be carried out prior to returning the compressor to the suppliers.
- Only electric heating to the compressor body shall be employed to accelerate this process.
- When oil is drained from a system, it shall be carried out safely.

6-8-2. Decommissioning

- Before carrying out this procedure, it is essential that the technician is completely familiar with the equipment and all its details. Only a qualified installer (*1) or qualified service person (*1) is allowed to do this work.
- It is recommended good practice that all refrigerants are recovered safely.
- Prior to the task being carried out, an oil and refrigerant sample shall be taken in case analysis is required prior to re-use of reclaimed refrigerant.
- It is essential that electrical power is available before the task is commenced.

NOTE

- a) Become familiar with the equipment and its operation.
- b) Isolate system electrically.
- c) Before attempting the procedure ensure that:
 - Mechanical handling equipment is available, if required, for handling refrigerant cylinders;
 - All personal protective equipment is available and being used correctly;
 - The recovery process is supervised at all times by a competent person;
 - Recovery equipment and cylinders conform to the appropriate standards.
- d) Pump down refrigerant system, if possible.
- e) If a vacuum is not possible, make a manifold so that refrigerant can be removed from the various parts of the system.
- f) Make sure that cylinder is situated on the scales before recovery takes place.
- g) Start the recovery machine and operate in accordance with manufacturers instructions.
- h) Do not overfill cylinders (No more than 80% volume liquid change).
- i) Do not exceed the maximum working pressure of the cylinder, even temporarily.
- j) When the cylinders have been filled correctly and the process complete, make sure that the cylinders and the equipment are removed from site promptly and all isolation valves on equipment are closed off.
- k) Recovered refrigerant shall not be changed into another refrigerant system unless it has been cleaned and checked.

(*1) Refer to the "Definition of Qualified Installer or Qualified Service Person"

6-8-3. Labelling

- Equipment shall be labelled stating that it has been de-commissioned and emptied of refrigerant.
- The label shall be dated and signed.
- Ensure that are labels on the equipment stating the equipment contains mildly flammable refrigerant.

7 CIRCUIT CONFIGURATION AND CONTROL SPECIFICATIONS

7-1. Outdoor Unit Control

7-1-1. Print Circuit Board, MCC-1768

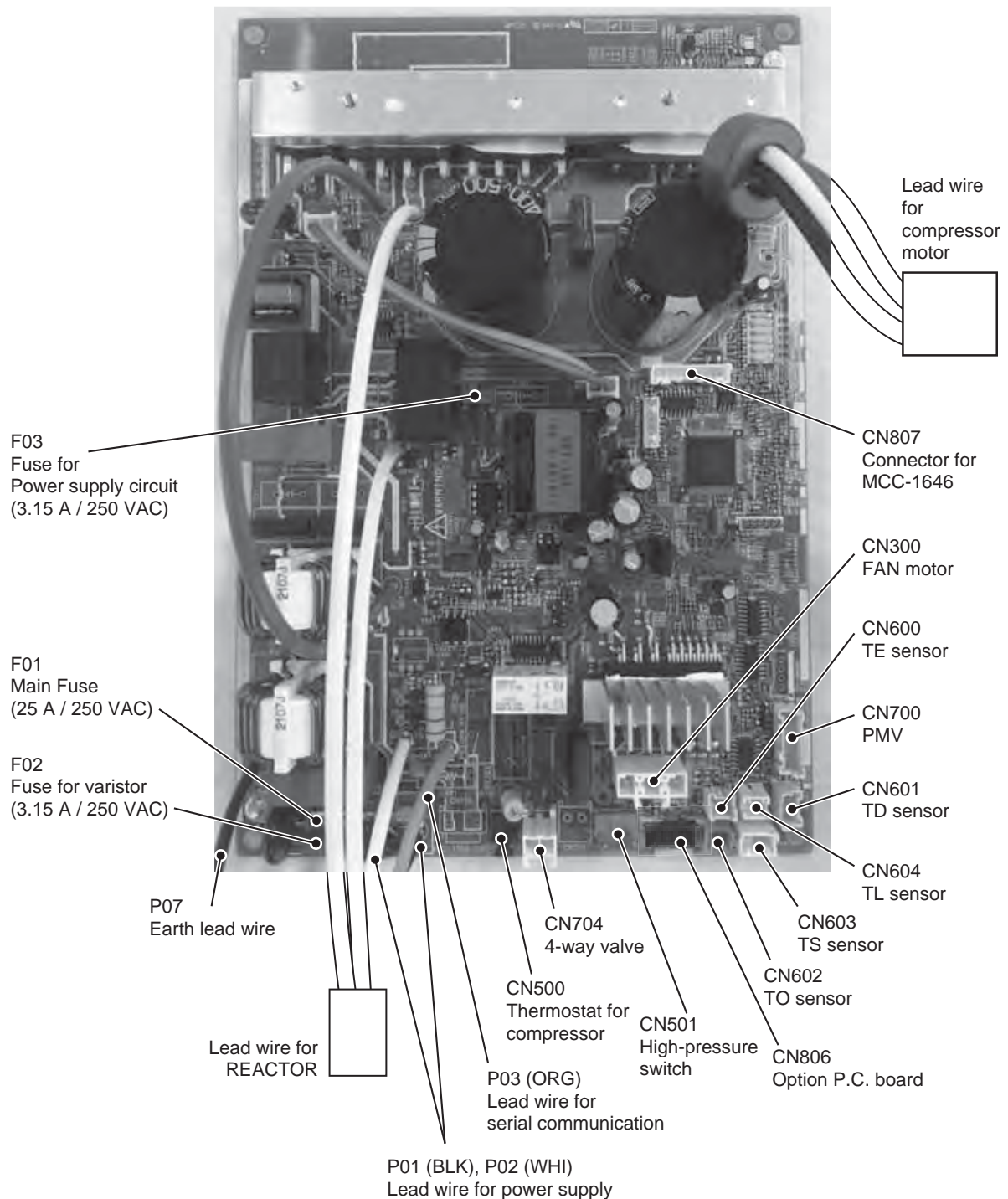

7-1-2. Print Circuit Board, MCC-1705

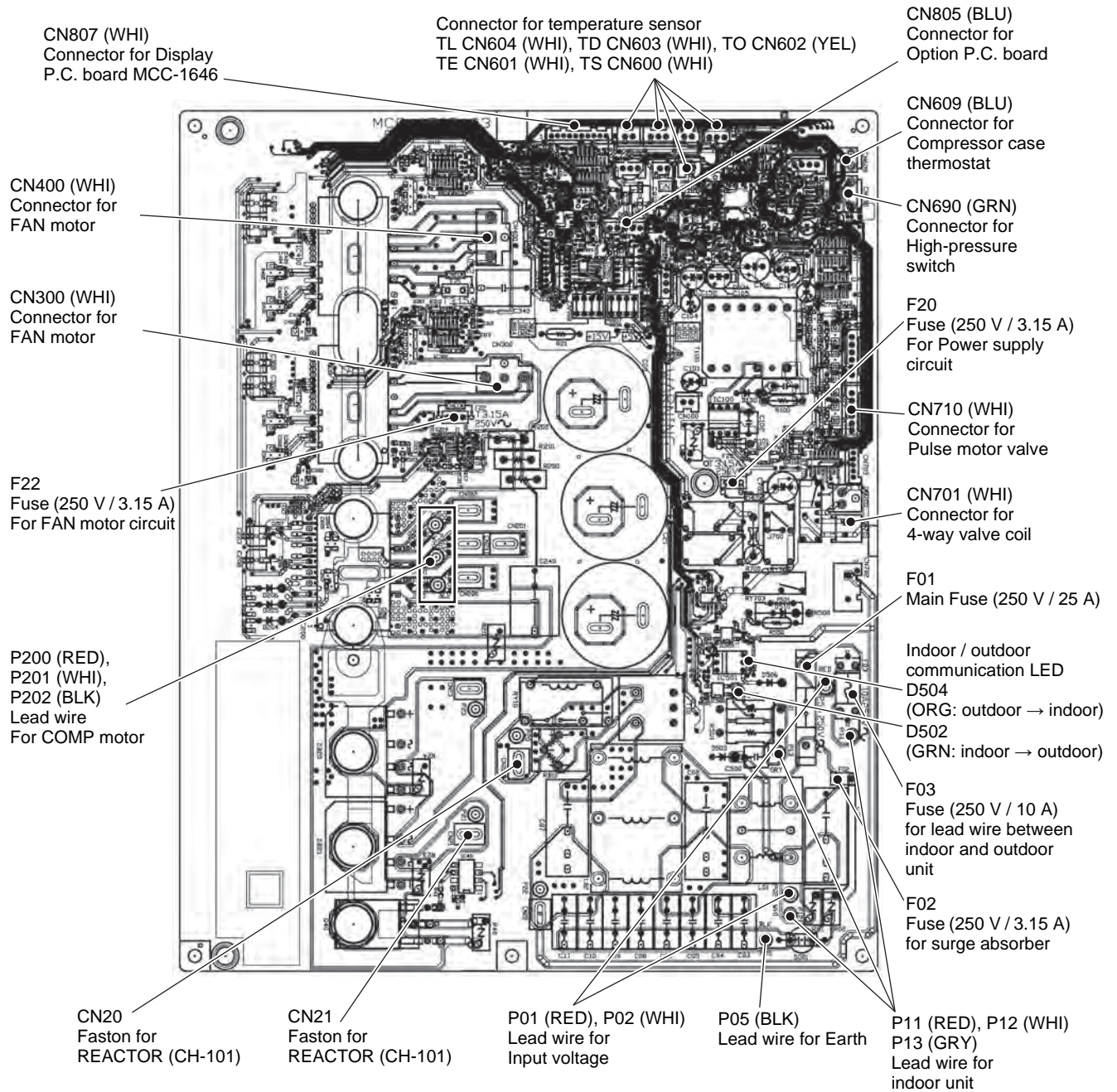

7-2. Outline of Main Controls

(1) PMV (Pulse Motor Valve) control

- (1) The aperture of the PMV is controlled between 30 to 500 pulses during operation.
- (2) During cooling operations, the PMV aperture is controlled by the temperature difference between TS sensor and TC sensor, the temperature difference in cooling operations is usually controlled using a 1 to 4K target value.
- (3) During heating operations, the PMV aperture is controlled by the temperature difference between TS sensor and TE sensor, the temperature difference in heating operations is usually controlled using a -1 to 4K target value.
- (4) When the cycle overheats during both cooling and heating operations, the PMV aperture is controlled using a detection value from a TD sensor.
The normal target value is 91°C for cooling operations and 96°C for heating operations.

⚠ CAUTION

Sensor malfunction may cause liquid back-flow or overheating trouble in the compressor resulting in dramatic reduction in the durable life of the compressor.

In the event of malfunction and repair of the compressor, restart operation after checking that there are no trouble in the resistance values or the refrigerating cycle of each sensor.

(2) Discharge temperature release control

- (1) This control lowers the revolution number of the compressor in the event that the discharge temperature is not reduced or in the event the discharge temperature increases rapidly during PMV control.
The cycle is stabilized by dividing compressor revolution number control into units up to 0.6 rps.
- (2) When the detected discharge temperature is in a trouble zone, compressor operation is stopped and then restarted after 2 minutes 30 seconds. A trouble count is added on each occasion the trouble zone is detected and when the trouble is detected 4 times, a "P03" trouble is performed. When normal operation continues for a period of 10 minutes, the trouble count is cleared. When the trouble is detected 4 times without the trouble count being cleared, the trouble is recognized so that the operation does not restart.

* An extremely less refrigerant, PMV failure and a cycle clogging etc may cause the malfunction of the operation.

- (3) For the indicated contents of trouble, confirm using the check code lists.

<GP56>

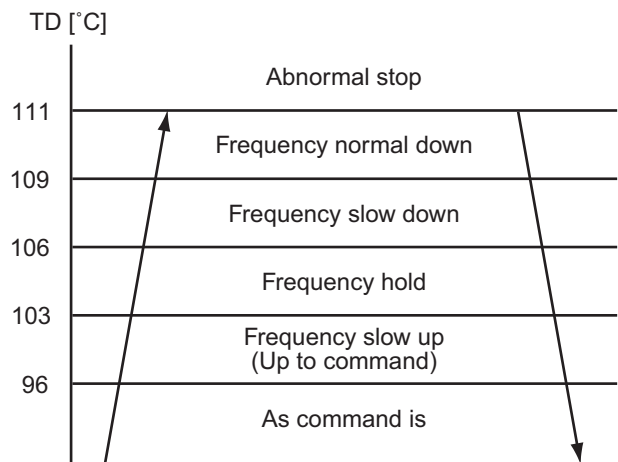

<GP80>

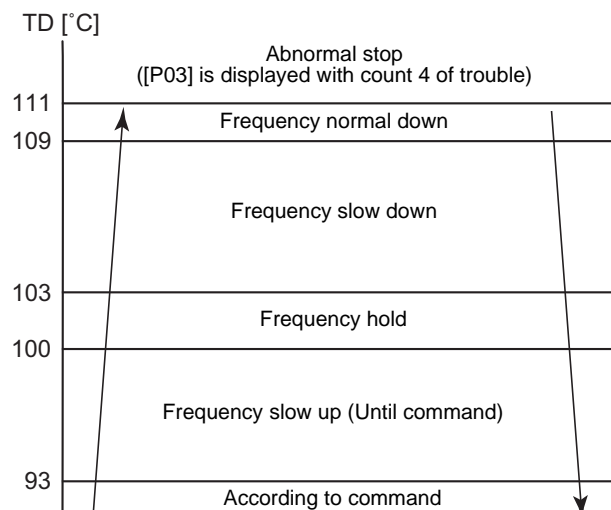

(3) Outdoor fan revolution number control

Control of fan revolution number and the fan taps in this unit are shown below.

Fan Taps Revolution number Allocation [rpm]

	W1	W2	W3	W4	W5	W6	W7	W8	W9	WA	WB	WC	WD	WE	WF
GP56	240	320	320	390	400	470	510	550	560	570	570	650	700	750	830
GP80	200	200	200	230	260	290	330	360	410	450	480	500	540	570	600

(3)-1. Cooling fan control

(1) Cooling operations of the outdoor fan are controlled by a TL sensor, TO sensor and the compressor revolution number.

The outdoor fan is controlled by every 1 tap of DC fan control (15 taps).

During startup, operation is fixed for 60 seconds by a maximum fan tap corresponding to the zones shown in the table below. Thereafter fan tap is controlled by a temperature outputted from the TL sensor.

GP56	20 rps or lower		20 rps to 45 rps		45 rps or higher	
	Min.	Max.	Min.	Max.	Min.	Max.
38°C ≤ TO	W6	WC	W8	WF	WA	WF
29°C ≤ TO < 38°C	W5	WB	W7	WD	W9	WD
15°C ≤ TO < 29°C	W4	W8	W6	WA	W8	WC
5°C ≤ TO < 15°C	W3	W6	W5	W8	W7	WA
0°C ≤ TO < 5°C	W2	W4	W4	W6	W5	W8
-4°C ≤ TO < 0°C	W2	W3	W3	W5	W4	W6
TO < -4°C	OFF	OFF	OFF	W1	OFF	W1
TO trouble	OFF	WC	OFF	WF	OFF	WF

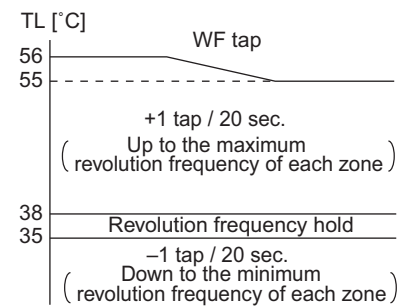

GP80	20 rps or lower		20 rps to 52 rps		52 rps or higher	
	Min.	Max.	Min.	Max.	Min.	Max.
38°C ≤ TO	W6	WB	W8	WE	WA	WE
29°C ≤ TO < 38°C	W5	WA	W7	WD	W9	WD
15°C ≤ TO < 29°C	W3	W7	W5	W9	W7	WB
5°C ≤ TO < 15°C	W2	W5	W4	W7	W6	W9
0°C ≤ TO < 5°C	W1	W3	W3	W5	W4	W7
-5°C ≤ TO < 0°C	W1	W2	W2	W4	W3	W5
TO < -5°C	OFF	OFF	OFF	W2	OFF	W3
TO trouble	OFF	WB	OFF	WE	OFF	WE

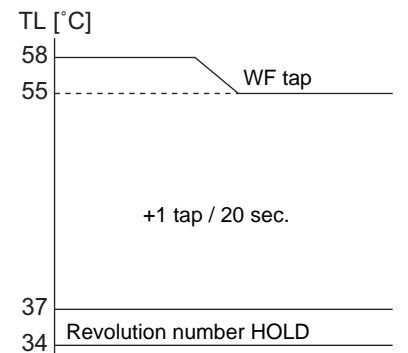

(3)-2. Heating fan control

- (1) Heating operations of the outdoor fan are controlled by a TE sensor, TO sensor and the compressor revolution number.
(Control from a minimum W1 to a maximum is performed according to the table below.)
- (2) Operation is fixed for 3 minutes after start up by a maximum fan tap corresponding to the zones in the table below. Thereafter fan control is performed using the temperature from the TE sensor.
- (3) When $TE \geq 24^{\circ}\text{C}$ continues for 5 minutes, the compressor is stopped. The compressor is placed in the same state as a normal thermostat OFF without a check code display.
The compressor is restarted after approximately 2 minutes 30 seconds and such interrupted operation does not constitute a trouble.
When the operation in (3) above is frequently performed, the filter of the intake section of the indoor unit may require cleaning.
Therefore restart operation after cleaning the filter.

GP56	20 rps or lower	20 rps to 45 rps	45 rps or higher	TE [$^{\circ}\text{C}$]
$10^{\circ}\text{C} \leq \text{TO}$	WA	WB	WC	24 -2 taps / 20 sec. (Down to W1) Stop timer count
$5^{\circ}\text{C} \leq \text{TO} < 10^{\circ}\text{C}$	WC	WC	WC	
$-3^{\circ}\text{C} \leq \text{TO} < 5^{\circ}\text{C}$	WC	WC	WF	21 -2 taps / 20 sec. (Down to W1)
$-10^{\circ}\text{C} \leq \text{TO} < -3^{\circ}\text{C}$	WF	WF	WF	18 -1 tap / 20 sec. (Down to W1)
$\text{TO} < -10^{\circ}\text{C}$	WF	WF	WF	15 Revolution frequency hold
TO trouble	WF	WF	WF	+1 tap / 20 sec. (Up to the maximum tap of each zone)

GP80	38 rps or lower	38 rps to 52 rps	52 rps or higher	TE [$^{\circ}\text{C}$]
$10^{\circ}\text{C} \leq \text{TO}$	W7	W8	W9	24 -2 taps / 20 sec. stop timer count (Until W1)
$5^{\circ}\text{C} \leq \text{TO} < 10^{\circ}\text{C}$	W9	WB	WD	
$-3^{\circ}\text{C} \leq \text{TO} < 5^{\circ}\text{C}$	WD	WD	WE	21 -2 taps / 20 sec. (Until W1)
$-10^{\circ}\text{C} \leq \text{TO} < -3^{\circ}\text{C}$	WE	WE	WE	18 -2 taps / 20 sec. (Until W1)
$\text{TO} < -10^{\circ}\text{C}$	WF	WF	WF	15 Revolution number HOLD
TO trouble	WF	WF	WF	+1 tap / 20 sec.

(4) Defrost control

- (1) During heating operations, defrost operations are performed when the temperature from the TE sensor satisfies any of the conditions in the A to D zones.
- (2) During defrosting operations, defrost will be terminated if the temperature from the TE sensor continues at 12°C or higher for 3 seconds or if the temperature is 7°C ≤ TE < 12°C for 1 minute. Furthermore the defrost operation will be terminated if defrosting operations have continued for 10 minutes even if TE sensor temperature is less than 7°C.
- (3) After defrost operations have been reset, the compressor restarts heating operations after it stops for 40 seconds.

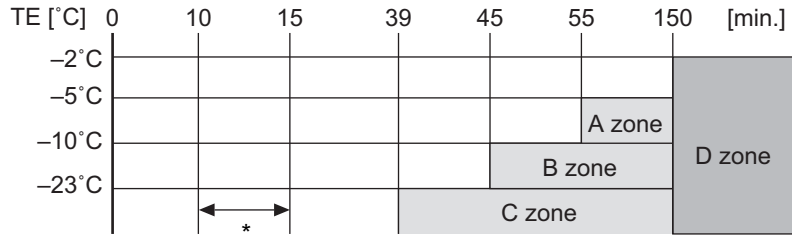

* The minimum TE value during 10 and 15 minutes after starting heating operation is stored as TEO. The minimum TO value during 10 and 15 minutes after starting heating operation is stored as ToO.

	When To is normal	When To is abnormal
A Zone	Status [(TEO-TE) – (ToO-TO) ≥ 3°C] continues for 20 seconds	Status [TEO-TE ≥ 3°C] continues for 20 seconds
B Zone	Status [(TEO-TE) – (ToO-TO) ≥ 2°C] continues for 20 seconds	Status [TEO-TE ≥ 2°C] continues for 20 seconds
C Zone	Status [TE ≥ 23°C] continues for 20 seconds	
D Zone	When compressor operation status TE < 2°C is calculated for 150 minutes	

(5) Short interrupted operation preventive control

- (1) Even when a thermostat OFF signal is received from the indoor unit, the compressor may not stop during 3 to 10 minute period after startup in order to protect the compressor. This operation is not a trouble condition. (The continuous operation time for compressor differs depending on the operational status.)
- (2) When operation is terminated by using a remote controller, operation will not continue.

(6) Electrical current release control

An AC current detection value from T10 on the P.C. board is used to suppress the revolution number of the compressor so that the input current of the inverter does not exceed a specified value.

A Zone	Normal operation.
D Zone	Maintain frequency of current operation.
B Zone	Reduce operating frequency.
C Zone	Cease reduction of operating frequency and maintain frequency of current operation.

I in value (A)	GP56	GP80
Cooling	12.4	17.0
Heating	12.4	20.0

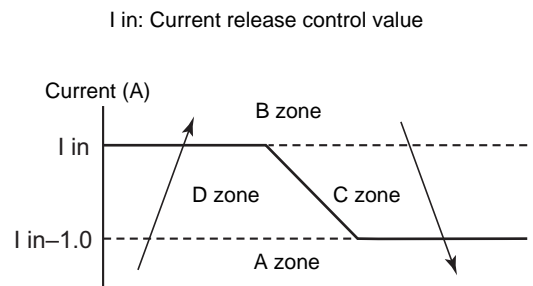

(7) Heat sink temperature detection control

- (1) IGBT overheating prevention is protective control performed by a thermistor (TH sensor) in proximity to IGBT.
 - (2) When a temperature of TH < 90°C is detected, the fan tap is moved by 1 step up.
Thereafter step-up is performed at a rate of +1 tap / 5 seconds until a maximum fan tap is reached.
 - (3) After (2) above, operation is returned to normal fan control at a temperature of TH < 85°C.
 - (4) Operation of the compressor is terminated at a temperature of TH < 110°C.
 - (5) Operation is restarted after 2 minutes and 30 seconds using [1] as the trouble count. However a count of [4] in the same operation confirms a trouble.
The check code display is "P07" (Restart will not be performed).
- * When trouble is confirmed, this may be a trouble caused by heat build-up or blower fan failure in the outdoor unit, or a trouble in the P.C. board.

(8) Electrical current release value shift control

- (1) This control is for the purpose of preventing malfunction of the compressor or electronic components such as the IGBT of the inverter in the compressor drive system during cooling operations.
- (2) Select the current release control value (I in) by TO sensor value from the right table.

The correction is based on the table below: (A)

Temp. range	GP56	GP80
50°C ≤ TO	9.6	8.5
47°C ≤ TO < 50°C	-	12.5
45°C ≤ TO < 50°C	10.0	-
44°C ≤ TO < 47°C	-	12.5
39°C ≤ TO < 45°C	11.6	-
39°C ≤ TO < 44°C	-	16.0
TO < 39°C	12.4	17.0
TO trouble	9.6	8.5

(9) Over-current protective control

- (1) Operation of the compressor is stopped when the over-current protective circuit detects a trouble current.
- (2) The compressor restarts after 2 minutes 30 seconds using [1] as a trouble count.
After restart, the trouble count is cleared when operation continues for 6 minutes or more.
- (3) A trouble is confirmed when the trouble count takes a value of [8], and operation does not restart.
- (4) For the indicated contents of trouble, confirm using the check code table.

(10) High-pressure switch / Compressor case thermostat control

- (1) When the high-pressure switch or the compressor case thermostat operates, the operation of the compressor is terminated.
- (2) The compressor restarts after 2 minutes 30 seconds using [1] as a trouble count.
After restart, the trouble count is cleared when operation continues for 10 minutes or more.
- (3) A trouble is confirmed with the trouble count [10].
- (4) For the indicated contents of trouble, confirm on the check code list.

(11) High-pressure release control

- (1) The operation frequency is controlled to restrain abnormal rising of high pressure by TL sensor in cooling operation and TC sensor in heating operation.
- (2) When TL sensor in cooling operation or TC sensor in heating operation detects abnormal temperature of the stop zone, the compressor is stopped and the trouble count becomes +1.
- (3) When the compressor stopped with (2), the operation restarts from the point of the normal operation zone (e point or lower) where it returned after 2 minutes 30 seconds.
- (4) The trouble count when the compressor stopped with (2) is cleared after the operation continued for 10 minutes. If the trouble count becomes [10] without being cleared, the trouble is determined and reactivation is not performed.
- (5) For the check code display contents, confirm on the check code list.

HEAT TC / COOL TL

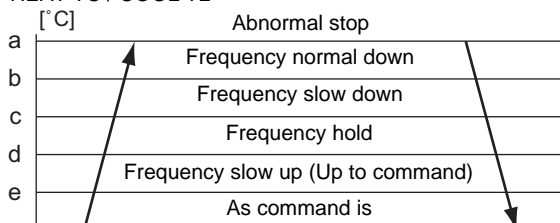

	HEAT		COOL	
	TC		TL	
	GP56	GP80	GP56	GP80
a	61°C	61°C	61°C	62°C
b	54°C	56°C	58°C	62°C
c	54°C	54°C	58°C	60°C
d	52°C	52°C	56°C	58°C
e	48°C	48°C	54°C	54°C

(12) Coil heating control

- (1) This control has the function of heating the compressor by applying a current to the compressor when not operating instead using a case heater.
This control is for the purpose of preventing stagnation of the refrigerant inside the compressor.
- (2) Malfunction in the compressor may result if a current is not applied for a specified time before a test run after installation as was previously the case.
Similarly, starting operation after turning the power OFF and not operating for a long time also requires application of a current before starting operation, in the same manner as the test run.
- (3) Application of current is determined by TD and TO sensors.
When the TO sensor is defective, a backup control is automatically performed by the TE sensor.
When TO sensor is defective, make a determination using the LED display of the P.C. board.
- (4) The power is turned off when TD is 30°C or more.

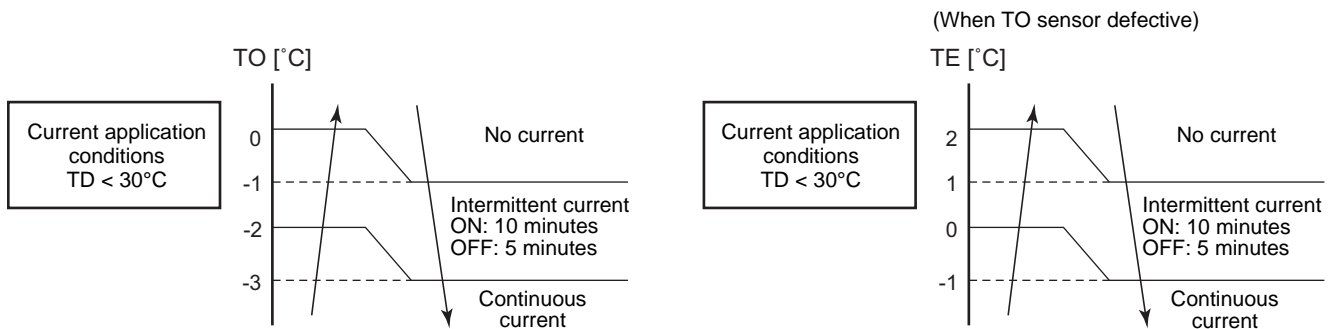

	GP56, GP80
Intermittent current	Corresponding to 40 W
Continuous current	Corresponding to 40 W

(70 W: Total power consumption of inverter and compressor)

NOTE

While heating and electrifying the winding wire, electrifying sound may generate. It is no abnormality.

8 TROUBLESHOOTING

8-1. Summary of Troubleshooting

<Wired remote controller type>

1. Before troubleshooting

(1) Required tools / instruments

- (+) and (–) screwdrivers, spanners, long-nose pliers, nippers, push pins for reset switch
- Tester, thermometer, pressure gauge, etc.

(2) Confirmation points before check

a) The following operations are normal.

1. Compressor does not operate.

- Is the air conditioner being controlled by the 3-minute protective function?
- Is it in standby status though the room temperature has reached the setup temperature?
- Is it being operated in timer mode or fan mode?
- Is an overflow trouble detected on the indoor unit?
- Is the remote controller set in “heating” under the high outside air temperature?

2. Indoor fan does not operate.

- Is the air conditioner being controlled by the cool air discharge preventive function in “heating”?

3. Outdoor fan does not operate or fan speed changes.

- Does high-temperature release operation control work in heating operation?
- Does outside low-temperature operation control work in cooling operation?
- Is defrost operation performed?

4. ON/OFF operation cannot be performed from remote controller.

- Is it being operated by the central control system?
- Is an automatic address being set up?
(When the power is turned on at the first time or when indoor unit address setting is changed, the operation cannot be performed for maximum approx. 5 minutes after power-ON.)
- Is being carried out a test run by operation of the outdoor unit?

5. LED for the indoor and outdoor communication does not flash.

- * Service switches (SW01 or SW02) on the outdoor unit allow.
- Does standby power saving operation control work?
(LED does flash, when the inside and outside communication is being stopped during the standby power saving control. Operating service switches (SW01 or SW02) on the outdoor unit allow to restart the communication.)

b) Did you return the wiring to the initial positions?

c) Are connecting wiring of indoor unit and remote controller correct?

2. Troubleshooting procedure

When a trouble occurred, check the parts along with the following procedure.

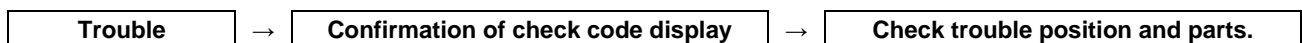

NOTE

For cause of a trouble except the items to be checked, miss diagnosis of microcomputer due to outer noise or power conditions is considered. If there is any noise source, change the wires of the remote controller to shield wires.

<Wireless remote controller type>

1. Before troubleshooting

(1) Required tools / instruments

- (+) and (–) screwdrivers, spanners, long-nose pliers, nippers, etc.
- Tester, thermometer, pressure gauge, etc.

(2) Confirmation points before check

a) The following operations are normal.

1. Compressor does not operate.

- Is the air conditioner being controlled by the 3-minute protective function?
- Is it in standby status though the room temperature has reached the setup temperature?
- Is it being operated in timer mode or fan mode?
- Is the remote controller set in “heating” under the high outside air temperature?

2. Indoor fan does not operate.

- Is the air conditioner being controlled by the cool air discharge preventive function in “heating”?

3. Outdoor fan does not operate or fan speed changes.

- Does high-temperature release operation control work in heating operation?
- Does outside low-temperature operation control work in cooling operation?
- Is defrost operation performed?

4. ON/OFF operation cannot be performed from remote controller.

- Is the air conditioner in forced operation?
- Is it being operated by the central control system?
- Is an automatic address being set up?
(When the power is turned on at the first time or when indoor unit address setting is changed, the operation cannot be performed for maximum approx. 5 minutes after power-ON.)
- Is a test run of the air conditioner being carried out?

5. LED for the indoor and outdoor communication does not flash.

* LED is placed on the outdoor unit P.C. board. (CDB P.C. board)

- Does standby power saving operation control work?
(LED does flash, when the inside and outside communication is being stopped during the standby power saving control. Operating service switches (SW01 or SW02) on the outdoor unit allow to restart the communication.)

b) Did you return the wiring to the initial positions?

c) Are connecting wires between indoor unit and receiving unit correct?

2. Troubleshooting procedure

When a trouble occurred, check the parts along with the following procedure.



8-2. Troubleshooting

8-2-1. Outline of judgment

The primary judgment to check whether a trouble occurred in the indoor unit or outdoor unit is carried out with the following method.



Method to judge the troubled position by flashing indication on the display part of the indoor unit. (sensors of the receiving part)

The indoor unit monitors the operating status of the air conditioner, and the blocked contents of self-diagnosis are displayed restricted to the following cases if a protective circuit works.

●: Go off, ○: Go on, ☼: Flash (0.5 sec.)

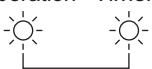
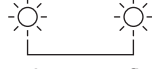
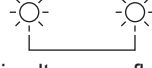
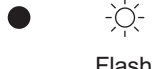
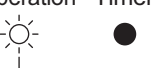

Lamp indication	Check code	Cause of trouble occurrence
Operation Timer Ready ● ● ● No indication at all	—	Power supply OFF or miswiring between receiving unit and indoor unit
Operation Timer Ready ☼ ● ● Flash	E01	Receiving trouble Receiving unit Miswiring or wire connection trouble between receiving unit and indoor unit Sending trouble Communication stop
	E02	
	E03	
	E08	Duplicated indoor unit No. Setup trouble
	E09	
	E10	Communication trouble between CPUs on indoor unit P.C. board
E18	Wire connection trouble between indoor units, Indoor power OFF (Communication stop between indoor header and follower or between header and follower indoor twin)	
Operation Timer Ready ● ● ☼ Flash	E04	Miswiring between indoor unit and outdoor unit or connection trouble (Communication stop between indoor and outdoor units)
Operation Timer Ready ● ☼ ☼ Alternate flash	P01	Overflow was detected Protective device of indoor unit worked Indoor DC fan trouble
	P10	
	P12	
Operation Timer Ready ☼ ● ☼ Alternate flash	P03	Outdoor unit discharge temp. trouble Protective device of outdoor unit worked *1 Outdoor high pressure system trouble
	P04	
	P05	Negative phase detection trouble Outdoor unit trouble Heat sink overheat trouble Gas leak detection trouble
	P07	
	P15	
	P19	4-way valve system trouble (Indoor or outdoor unit judged.)
	P20	Outdoor unit high pressure protection
	P22	Outdoor unit: Outdoor unit trouble Protective device of outdoor unit worked *1 Outdoor unit: Inverter Idc operation Outdoor unit: Position detection trouble
	P26	
	P29	
P31	Stopped because of trouble of other indoor unit in a group (Check codes of E03 / L03 / L07 / L08)	

*1: These are representative examples and the check code differs according to the outdoor unit to be combined.

Lamp indication	Check code	Cause of trouble occurrence
Operation Timer Ready  Alternate flash	F01	Heat exchanger sensor (TCJ) trouble Heat exchanger sensor (TC) trouble Room air temperature sensor (TA) trouble } Indoor unit sensor trouble
	F02	
	F10	
Operation Timer Ready  Alternate flash	F04	Discharge temp. sensor (TD) trouble Temp. sensor (TE) trouble Temp. sensor (TL) trouble Temp. sensor (TO) trouble Temp. sensor (TS) trouble Temp. sensor (TH) trouble Temp. sensor miswiring (TE, TS) } Sensor trouble of outdoor unit *1
	F06	
	F07	
	F08	
	F12	
	F13	
F15		
Operation Timer Ready  Simultaneous flash	F29	Indoor EEPROM trouble
Operation Timer Ready  Simultaneous flash	F31	Outdoor EEPROM trouble
Operation Timer Ready  Flash	H01	Compressor break down Compressor lock Current detection circuit trouble Case thermostat worked PS pressure sensor trouble low pressure protective operation } Outdoor compressor system trouble *1 } Power supply, outdoor P.C. board trouble } Compressor overheat, outdoor wiring trouble Outdoor unit low pressure system trouble
	H02	
	H03	
	H04	
	H06	
Operation Timer Ready  Simultaneous flash	L03	Duplicated header indoor units There is indoor unit of group connection in individual indoor unit Unsetting of group address Missed setting (Unset indoor capacity) } →AUTO address * If group construction and address are not normal when power supply turned on, automatically goes to address setup mode.
	L07	
	L08	
	L09	
Operation Timer Ready  Simultaneous flash	L10	Unset model type (Service P.C. board)
	L20	Duplicated indoor central addresses
	L29	Outdoor unit and other trouble
	L30	Outside interlock trouble
	L31	Negative phase trouble

*1: These are representative examples and the check code differs according to the outdoor unit to be combined.

8-2-2. Others (Other than Check Code)

Lamp indication	Check code	Cause of trouble occurrence
Operation Timer Ready  Simultaneous flash	—	During test run
Operation Timer Ready  Alternate flash	—	Disagreement of cool / heat (Automatic cool / heat setting to automatic cool / heat prohibited model, or setting of heating to cooling-only model)

8-2-3. Monitor Function of Remote Controller Switch

Calling of sensor temperature display

<Contents>

Each data of the remote controller, indoor unit and outdoor unit can be understood by calling the service monitor mode from the remote controller.

<Procedure>

- 1 Push **TEST** + **CL** buttons simultaneously for 4 seconds to call the service monitor mode.

The service monitor goes on, the header indoor unit No. is displayed at first and then the temperature of CODE No. 00 is displayed.



- 2 Push temperature set **TEMP.** buttons and then change the CODE No. of data to be monitored.

The CODE No. list is shown below.

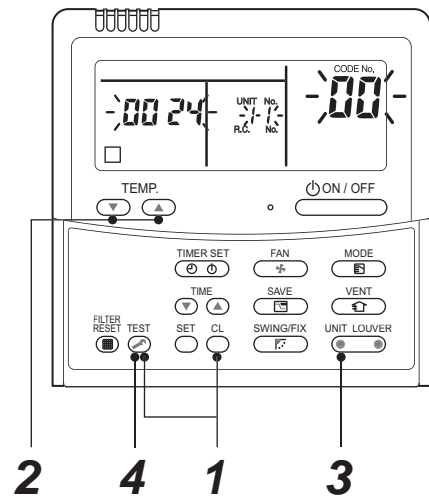

<Operation procedure>

1 → 2 → 3 → 4

Returned to usual display

	CODE No.	Data name	Unit
Indoor unit data	01	Room temperature (Remote controller)	°C
	02	Indoor room air temperature (TA)	°C
	03	Indoor heat exchanger (Coil) temperature (TCJ)	°C
	04	Indoor heat exchanger (Coil) temperature (TC)	°C
	07	Indoor fan revolution frequency	rpm
	F2	Indoor fan calculated operation time	x100h
	F3	Indoor unit fan cumulative operating hours	x1h
	F8	Indoor discharge temperature	°C

	CODE No.	Data name	Unit
Outdoor unit data	60	Outdoor heat exchanger (Coil) temperature (TE)	°C
	61	Outside temperature (TO)	°C
	62	Compressor discharge temperature (TD)	°C
	63	Compressor suction temperature (TS)	°C
	65	Heat sink temperature (THS)	°C
	6A	Operation current (x1/10)	A
	6D	Outdoor heat exchanger (Coil) temperature (TL)	°C
	70	Compressor operation frequency	rps
	72	Outdoor fan revolution frequency (Lower)	rpm
	73	Outdoor fan revolution frequency (Upper)	rpm
	F1	Compressor calculated operation time	x100h



- 3 Push **UNIT LOUVER** button to select the indoor unit to be monitored. Each data of the indoor unit and its outdoor units can be monitored.



- 4 Pushing **TEST** button returns the status to the usual display.

The indoor discharge temperature of CODE No. [F8] is the estimated value from TC or TCJ sensor. Use this value to check discharge temperature at test run.

(A discharge temperature sensor is not provided to this model.)

- The data value of each item is not the real time, but value delayed by a few seconds to ten-odd seconds.

8-2-4. Check Code List (Outdoor)

○ : Go on, ◐ : Flash, ● : Go off
 ALT (Alternate): Alternate flashing when there are two flashing LED.
 SIM (Simultaneous): Simultaneous flashing when there are two flashing LED.

Remote controller indication	Wireless receiver Block indication		Representative trouble position	Detection	Explanation of trouble contents	Automatic reset	Operation continuation
	Operation	Timer Ready					
F04	○	○	Outdoor unit discharge temp. sensor (TD) trouble	Outdoor	Open / Short-circuit of discharge temp. sensor was detected.	—	—
F06	○	○	Outdoor unit temp. sensor (TE, TS, TL) trouble	Outdoor	Open / Short-circuit of heat exchanger temp. sensor was detected. Miswiring between TE sensor and TS sensor.	—	—
F08	○	○	Outdoor unit outside temp. sensor (TO) trouble	Outdoor	Open / Short-circuit of outside temp. sensor was detected.	✓	—
F07	○	○	Outdoor unit temp. sensor (TL) trouble	Outdoor	Open / Short-circuit of heat exchanger temp. sensor was detected.	—	—
F12	○	○	Outdoor unit temp. sensor (TS) trouble	Outdoor	Open / Short-circuit of suction temp. sensor was detected.	—	—
F13	○	○	Outdoor unit temp. sensor (TH) trouble	Outdoor	Open / Short-circuit of heat sink temp. sensor (P.C. board installed) was detected.	—	—
F15	○	○	Outdoor unit disconnection of temp. sensor (TE, TS)	Outdoor	Misconnection of outdoor heat exchanger temp. sensor and suction temp. sensor was detected.	—	—
F31	○	○	Outdoor unit EEPROM trouble	Outdoor	Outdoor P.C. board part (EEPROM) trouble was detected.	—	—
H01	●	○	Outdoor unit compressor break down	Outdoor	When reached min-Hz by current release control, short-circuited current (Idc) after DC excitation was detected.	—	—
H02	●	○	Outdoor unit compressor lock	Outdoor	Compressor lock was detected.	—	—
H03	●	○	Outdoor unit current detection circuit trouble	Outdoor	Current detection circuit trouble.	—	—
H04	●	○	Outdoor unit case thermostat operation	Outdoor	Case thermostat operation was detected.	—	—
L10	○	○	Outdoor unit setting trouble of service P.C. board type	Outdoor	When outdoor service P.C. board was used, model type select jumper setting was inappropriate.	—	—
L29	○	○	Outdoor unit other outdoor unit trouble	Outdoor	1) Defective parts on outdoor P.C. board. (MCU communication, EEPROM, TH sensor trouble.) 2) When outdoor service P.C. board was used, model type selection was inappropriate. 3) Other trouble (Heat sink abnormal overheating, gas leak, 4-way valve inverse trouble) was detected. Trouble was detected by discharge temp. release control.	—	—
P03	○	○	Outdoor unit discharge temp. trouble	Outdoor	When case thermostat worked, trouble was detected by high release control from indoor / outdoor heat exchanger temp. sensor. Power supply voltage trouble.	—	—
P04	○	○	High pressure system trouble, power supply voltage trouble	Outdoor	Power supply voltage trouble.	—	—
P05	○	○	Power supply trouble	Outdoor	Abnormal overheating was detected by outdoor heat sink temp. sensor.	—	—
P07	○	○	Outdoor unit heat sink overheating	Outdoor	Abnormal overheating of discharge temp. or suction temp. was detected.	—	—
P15	○	○	Gas leak detection	Outdoor	Trouble was detected by high release control from indoor / outdoor heat exchanger temp. sensor.	—	—
P20	○	○	Outdoor unit high pressure system trouble	Outdoor	Trouble (Over-current, lock, etc.) was detected on outdoor fan drive circuit.	—	—
P22	○	○	Outdoor unit outdoor fan trouble	Outdoor	Short-circuited protective operation of compressor drive circuit element (G-Tr / IGBT) worked.	—	—
P26	○	○	Outdoor unit inverter Idc operation	Outdoor	Position detection trouble of compressor motor was detected.	—	—
P29	○	○	Outdoor unit position detection trouble	Outdoor	Signal was not received from indoor unit.	—	—
E01	○	●	No remote controller header unit Remote controller communication trouble	Remote controller	Master remote controller was not set. (including 2 remote controllers)	—	—
E02	○	●	Remote controller send trouble	Remote controller	Signal cannot be sent to indoor unit.	—	—
E03	○	●	Regular communication trouble between indoor and remote controller	Indoor	No communication from remote controller and "1 : 1 Model" Connection Interface.	✓	—
E04	●	○	Indoor / Outdoor serial trouble	Indoor	Serial communication trouble between indoor and outdoor.	✓	—
E08	○	●	Duplicated indoor addresses	Indoor	Same address as yours was detected.	✓	—
E09	○	●	Duplicated master remote controllers	Remote controller	In 2-remote controller, both were set as header. (Indoor header unit stops warning and follower unit continues operation.)	—	—
E10	○	●	Communication trouble between CPU and follower indoor units	Indoor	MCU communication trouble between main motor and micro computer.	✓	△
E18	○	●	Regular communication trouble between header and follower indoor units	Indoor	Regular communication was impossible between header and follower indoor units. Communication between twin header (Master unit) and follower (sub unit) was impossible.	✓	—
L03	○	○	Duplicated indoor header units	Indoor	There are multiple header units in a group.	—	—
L07	○	○	There are group control wires in individual indoor unit.	Indoor	When even one group connection indoor unit exists in individual indoor unit.	—	—
L08	○	○	Unset indoor group address	Indoor	Indoor address group was unset.	—	—
L09	○	○	Unset indoor capacity	Indoor	Capacity of indoor unit was unset.	—	—
L30	○	○	Outside trouble input to indoor unit (Interlock)	Indoor	Abnormal stop by CN80 outside trouble input.	—	—
P19	○	○	4-way valve inverse trouble	Indoor Outdoor	In heating operation, trouble was detected by temp. down of indoor heat exchanger or temp. up of TE, TS.	—	—

◇ : When this warning was detected before group construction / address check finish at power supply was turned on, the mode shifts automatically to AUTO address setup mode.
 △ : It is based on a situation.

○ : Go on, ◯ : Flash, ● : Go off
 ALT (Alternate): Alternate flashing when there are two flashing LED.
 SIM (Simultaneous): Simultaneous flashing when there are two flashing LED.

Remote controller indication	Wireless receiver Block indication			Representative trouble position	Detection	Explanation of trouble contents	Automatic reset	Operation continuation
	Operation	Timer	Ready					
F01	○	○	●	Indoor unit heat exchanger sensor (TC-U) trouble	Indoor	Open / Short-circuit of heat exchanger (TC-U) was detected.	✓	—
F02	○	○	●	Indoor unit heat exchanger sensor (TC) trouble	Indoor	Open / Short-circuit of heat exchanger (TC) was detected.	✓	—
F10	○	○	●	Indoor unit room air temp. sensor (TA) trouble	Indoor	Open / Short-circuit of room air temp. (TA) was detected.	✓	—
F29	○	○	●	Indoor unit other indoor P.C. board trouble	Indoor	EEPROM trouble (Other trouble may be detected. If no trouble, automatic address is repeated.)	—	—
P01	●	○	○	Indoor unit indoor fan trouble	Indoor	Indoor AC fan trouble was detected. (Fan thermal relay worked.)	—	—
P10	●	○	○	Indoor unit overflow detection	Indoor	Float switch worked.	—	—
P12	●	○	○	Indoor unit fan trouble	Indoor	Indoor fan trouble (Over-current / Lock, etc.) was detected.	—	—
P31	○	●	○	Other indoor unit trouble	Indoor	Other indoor unit under condition of warning in group. E03 / L07 / L03 / L08 warning.	✓	—
—	By unit with warning No.			Trouble in indoor group	"1 : 1 Model" Connection Interface	Sub remote controller trouble in a group. (Details of remote controller are displayed with unit No. Only central control system side is displayed.)	—	—
—				LAN system communication trouble	"1 : 1 Model" Connection Interface / Central control system	Communication trouble of central control system signal. * Is not displayed on the remote controller.	✓	✓
L20	○	○	○	LAN system communication trouble	"1 : 1 Model" Connection Interface / Central control system	Duplicated indoor address of central control system communication.	✓	—
—				There are multiple communication adapters	"1 : 1 Model" Connection Interface	There are multiple communication adapters on remote controller communication line.	✓	✓

*1 : 1 Model" Connection Interface: TCB-PCNT30TLE2

Failure mode detected by indoor unit

Operation of diagnostic function				Judgment and measures
Check code	Cause of operation	Status of air conditioner	Condition	
E03	No communication from remote controller (including wireless) and communication adapter	Stop (Automatic reset)	Displayed when trouble is detected	1. Check control wires of remote controller and communication adapters. • Remote controller LCD display OFF (Disconnection). • Central remote controller [97] check code.
E04	The serial signal is not output from outdoor unit to indoor unit. • Miswiring of inter-unit wire • Serial communication circuit trouble of outdoor P.C. board • Serial communication circuit trouble of indoor P.C. board	Stop (Automatic reset)	Displayed when trouble is detected	1. Outdoor unit does not completely operate. • Inter-unit wire check, correction of miswiring. • Check outdoor P.C. board. Correct wiring of P.C. board. 2. When outdoor unit normally operates. • Check P.C. board (Indoor receiving / Outdoor sending).
E08	Duplicated indoor unit address	Stop	Displayed when trouble is detected	1. Check whether remote controller connection (Group / Individual) was changed or not after power supply turned on (Finish of group construction / Address check). * If group construction and address are not normal when the power has been turned on, the mode automatically shifts to address setup mode. (Resetting of address)
L03	Duplicated indoor header unit			
L07	There is group wire in individual indoor unit			
L08	Unset indoor group address			
L09	Unset indoor capacity	Stop	Displayed when trouble is detected	1. Set indoor capacity (DN = 11).
L30	Abnormal input of outside interlock	Stop	Displayed when trouble is detected	1. Check outside devices. 2. Check indoor P.C. board.
P10	Float switch operation • Float circuit, Disconnection, Coming-off, Float switch contact trouble	Stop	Displayed when trouble is detected	1. Trouble of drain pump. 2. Clogging of drain pump. 3. Check float switch. 4. Check indoor P.C. board.
P12	Indoor DC fan trouble	Stop	Displayed when trouble is detected	1. Position detection trouble. 2. Over-current protective circuit of indoor fan driving unit operated. 3. Indoor fan locked. 4. Check indoor P.C. board.
P19	4-way valve system trouble • After heating operation has started, indoor heat exchangers temp. is down.	Stop (Automatic reset)	Displayed when trouble is detected	1. Check 4-way valve. 2. Check 2-way valve and check valve. 3. Check indoor heat exchanger (TC / TCJ). 4. Check indoor P.C. board.
P31	Unit automatically stops while warning is output to other indoor units.	Stop (Follower unit) (Automatic reset)	Displayed when trouble is detected	1. Judge follower unit while header unit is [E03], [L03], [L07] or [L08]. 2. Check indoor P.C. board.
F01	Coming-off, disconnection or short-circuit of indoor heat exchanger temp. sensor (TCJ)	Stop (Automatic reset)	Displayed when trouble is detected	1. Check indoor heat exchanger temp. sensor (TCJ). 2. Check indoor P.C. board.
F02	Coming-off, disconnection or short-circuit of indoor heat exchanger temp. sensor (TC)	Stop (Automatic reset)	Displayed when trouble is detected	1. Check indoor heat exchanger temp. sensor (TC). 2. Check indoor P.C. board.
F10	Coming-off, disconnection or short-circuit of indoor room air temp. sensor (TA)	Stop (Automatic reset)	Displayed when trouble is detected	1. Check indoor room air temp. sensor (TA). 2. Check indoor P.C. board.
F29	Indoor EEPROM trouble • EEPROM access trouble	Stop (Automatic reset)	Displayed when trouble is detected	1. Check indoor EEPROM. (including socket insertion) 2. Check indoor P.C. board.
E10	Communication trouble between indoor MCU • Communication trouble between fan driving MCU and main MCU	Stop (Automatic reset)	Displayed when trouble is detected	1. Check indoor P.C. board.
E18	Regular communication trouble between indoor header and follower units and between master and sub units	Stop (Automatic reset)	Displayed when trouble is detected	1. Check remote controller wiring. 2. Check indoor power supply wiring. 3. Check indoor P.C. board.

Failure mode detected by outdoor unit

Operation of diagnostic function				Judgment and measures
Check code	Cause of operation	Status of air conditioner	Condition	
F04	Disconnection, short-circuit of discharge temp. sensor (TD)	Stop	Displayed when trouble is detected	1. Check discharge temp. sensor (TD). 2. Check outdoor P.C. board (GP56: MCC-1768, GP80: MCC-1705).
F06	Disconnection, short-circuit of outdoor temp. sensor (TE)	Stop	Displayed when trouble is detected	1. Check temp. sensor (TE). 2. Check outdoor P.C. board (GP56: MCC-1768, GP80: MCC-1705).
F07	Disconnection, short-circuit of outdoor temp. sensor (TL)	Stop	Displayed when trouble is detected	1. Check temp. sensor (TL). 2. Check outdoor P.C. board (GP56: MCC-1768, GP80: MCC-1705).
F12	Disconnection, short-circuit of suction temp. sensor (TS)	Stop	Displayed when trouble is detected	1. Check suction temp. sensor (TS). 2. Check outdoor P.C. board (GP56: MCC-1768, GP80: MCC-1705).
F15	Miss-mounting of outdoor temp. sensor (TE, TS)	Stop	Displayed when trouble is detected	1. Check temp. sensor (TE, TS). 2. Check outdoor P.C. board (GP56: MCC-1768, GP80: MCC-1705).
F08	Disconnection, short-circuit of outside temp. sensor (TO)	Continue	Displayed when trouble is detected	1. Check outside temp. sensor (TO). 2. Check outdoor P.C. board (GP56: MCC-1768, GP80: MCC-1705).
F13	Disconnection, short-circuit of heat sink temp. sensor (TH)	Stop	Displayed when trouble is detected	1. Check outdoor P.C. board (GP56: MCC-1768, GP80: MCC-1705). (Q201 is incorporated in TH sensor.)
F31	Outdoor P.C. EEPROM trouble	Stop	Displayed when trouble is detected	1. Check outdoor P.C. board (GP56: MCC-1768, GP80: MCC-1705).
L10	Unset jumper of service P.C. board	Stop	Displayed when trouble is detected	1. Outdoor service P.C. board. Check model type setting jumper wire.
L29	Communication trouble between outdoor P.C. board MCU	Stop	Displayed when trouble is detected	1. Check outdoor P.C. board (GP56: MCC-1768, GP80: MCC-1705).
P07	Heat sink overheat trouble * Heat sink temp. sensor detected over specified temperature.	Stop	Displayed when trouble is detected	1. Check screw tightening between P.C. board and heat sink and check radiator grease (GP56: MCC-1768, GP80: MCC-1705). 2. Check heat sink blast path.
P15	Detection of gas leak * Discharge temp. sensor (TD), Suction temp. sensor (TS) detected temperature over specified temp.	Stop	Displayed when trouble is detected	1. Check gas leak, recharge. 2. Check full open of service valve. 3. Check PMV (Pulse Motor Valve). 4. Check broken pipe. 5. Check discharge temp. sensor (TD), suction temp. sensor (TS).
P19	4-way valve inverse trouble * After heating operation has started, indoor heat exchanger temp. lowers under the specified temp. * After heating operation has started, outdoor heat exchanger / suction temp. rises over the specified temp.	Stop	Displayed when trouble is detected	1. Check operation of 4-way valve. 2. Check outdoor heat exchanger (TE), suction temp. sensor (TS). 3. Check indoor heat exchanger sensor (TC). 4. Check 4-way valve coil. 5. Check PMV (Pulse Motor Valve).
H01	Compressor break down * Although operation has started, operation frequency decreases and operation stops.	Stop	Displayed when trouble is detected	1. Check power supply voltage. (AC198 to 264 V) 2. Overload operation of refrigerating cycle.
H02	Compressor lock * Over-current detection after compressor start-up	Stop	Displayed when trouble is detected	1. Trouble of compressor (Lock, etc.): Replace compressor. 2. Wiring trouble of compressor (Open phase).
H03	Current detection circuit trouble	Stop	Displayed when trouble is detected	1. Check outdoor P.C. board (GP56: MCC-1768, GP80: MCC-1705). (AC current detection circuit)
F23	Ps sensor trouble	Stop	Displayed when trouble is detected	1. Check connection of Ps sensor connector. 2. Check failure of Ps sensor. 3. Check compressing power trouble of compressor. 4. Check 4-way valve trouble. 5. Check outdoor P.C. board trouble.
P03	Discharge temp. trouble * Discharge temp. (TD) over specified value was detected.	Stop	Displayed when trouble is detected	1. Check refrigerating cycle (Gas leak). 2. Trouble of electronic expansion valve. 3. Check discharge temp. sensor (TD).

Operation of diagnostic function				Judgment and measures
Check code	Cause of operation	Status of air conditioner	Condition	
H04	Case thermostat operation * Abnormal overheat of compressor	Stop	Displayed when trouble is detected	1. Check case thermostat and connector. 2. Check gas leak, recharge. 3. Check full open of service valve. 4. Check PMV (Pulse Motor Valve). 5. Check broken pipe.
P04	High pressure SW system trouble	Stop	Displayed when trouble is detected	1. Check service valves are fully opened. (Gas side, Liquid side) 2. Check of outdoor fan operation. 3. Check motor trouble of outdoor fan. 4. Check clogging of outdoor PMV. 5. Check clogging of heat exchanger in indoor / outdoor units. 6. Short-circuit status of suction / discharge air in outdoor unit. 7. Check outdoor P.C. board trouble. 8. Check fan system trouble (Cause of air volume drop) at indoor side. 9. Check PMV opening status in indoor unit.
P05	Power supply voltage trouble	Stop	Displayed when trouble is detected	1. Check power supply voltage. (AC198 to 264 V)
	High pressure SW system trouble	Stop	Displayed when trouble is detected	1. Check service valves are fully opened. (Gas side, Liquid side) 2. Check of outdoor fan operation. 3. Check motor trouble of outdoor fan. 4. Check clogging of outdoor PMV. 5. Check clogging of heat exchanger in indoor / outdoor units. 6. Short-circuit status of suction / discharge air in outdoor unit. 7. Check outdoor P.C. board trouble. 8. Check fan system trouble (Cause of air volume drop) at indoor side. 9. Check PMV opening status in indoor unit.
P20	High pressure protective operation * During cooling operation, outdoor temp. sensor (TL) detected temperature over specified temp. * During heating operation, indoor temp. sensor (TC, TCJ) detected temperature over specified temp.	Stop	Displayed when trouble is detected	1. Check outdoor heat exchanger sensor (TL). 2. Check indoor heat exchanger sensor (TC, TCJ). 3. Check full open of service valve. 4. Check indoor / outdoor fan. 5. Check PMV (Pulse Motor Valve). 6. Check clogging and short-circuit of indoor / outdoor heat exchanger. 7. Overcharge of refrigerant. Recharge.
P22	Outdoor fan system trouble	Stop	Displayed when trouble is detected	1. Check lock of fan motor. 2. Check power supply voltage between L2 and N. (AC198 to 264 V) 3. Check outdoor P.C. board.
P26	Short-circuit trouble of compressor driving element	Stop	Displayed when trouble is detected	1. When performing operation while taking-off compressor wire, P26 trouble occurs. Check outdoor P.C. board (GP56: MCC-1768, GP80: MCC-1705). 2. When performing operation while taking-off compressor wire, an trouble does not occur. (Compressor layer short-circuit)
P29	Position detection circuit trouble	Stop	Displayed when trouble is detected	1. Check outdoor P.C. board (GP56: MCC-1768, GP80: MCC-1705).

Failure mode detected by remote controller or central controller (TCC-LINK)

Operation of diagnostic function				Judgment and measures
Check code	Cause of operation	Status of air conditioner	Condition	
Not displayed at all (Operation on remote controller is impossible.)	No communication with header indoor unit <ul style="list-style-type: none"> Remote controller wiring is not correct. Power of indoor unit is not turned on. Automatic address cannot be completed. 	Stop	—	Power supply trouble of remote controller, Indoor EEPROM trouble 1. Check remote controller inter-unit wiring. 2. Check remote controller. 3. Check indoor power wiring. 4. Check indoor P.C. board. 5. Check indoor EEPROM. (including socket insertion) → Automatic address repeating phenomenon generates.
E01 *1	No communication with header indoor unit <ul style="list-style-type: none"> Disconnection of inter-unit wire between remote controller and header indoor unit (Detected by remote controller side) 	Stop (Automatic reset) * If central controller exists, operation continues.	Displayed when trouble is detected	Receiving trouble from remote controller 1. Check remote controller inter-unit wiring. 2. Check remote controller. 3. Check indoor power wiring. 4. Check indoor P.C. board.
E02	Signal send trouble to indoor unit (Detected by remote controller side)	Stop (Automatic reset) * If central controller exists, operation continues.	Displayed when trouble is detected	Sending trouble of remote controller 1. Check sending circuit inside of remote controller. → Replace remote controller.
E09	There are multiple master remote controllers. (Detected by remote controller side)	Stop (Follower unit continues operation.)	Displayed when trouble is detected	1. In 2-remote controllers (including wireless), there are multiple header units. Check that there are 1 master remote controller and other sub remote controllers.
L20 ----- Central controller L20	Duplicated indoor central addresses on communication of central control system (Detected by indoor / central controller side)	Stop (Automatic reset)	Displayed when trouble is detected	1. Check setting of central control system network address. ("1 : 1 Model" Connection Interface SW01) 2. Check "1 : 1 Model" Connection Interface P.C. board.
— *2 ----- Central controller (Send) C05 (Receive) C06	Communication circuit trouble of central controller (Detected by central controller side)	Continues (By remote controller)	Displayed when trouble is detected	1. Check communication wire / miswiring 2. Check communication (U3, U4 terminals) 3. Check "1 : 1 Model" Connection Interface P.C. board. 4. Check central controller (such as central control remote controller, etc.) 5. Check terminal resistance. (TCC-LINK)
----- Central controller P30	Indoor Gr sub unit trouble (Detected by central controller side)	Continuation / Stop (According to each case)	Displayed when trouble is detected	Check the check code of the corresponding unit from remote controller.

"1 : 1 Model" Connection Interface: TCB-PCNT30TLE2

*1 The check code cannot be displayed by the wired remote controller.
 (Usual operation of air conditioner becomes unavailable.)
 For the wireless models, a trouble is notified with indication lamp.

*2 This trouble is related to communication of remote controller (A, B), central system (TCC-LINK U3, U4), and [E01], [E02], [E03], [E09] or [E18] is displayed or no check display on the remote controller according to the contents.

8-2-5. Diagnostic Procedure for Each Check Code (Outdoor Unit)

- (1) This section describes the diagnostic method for each check code displayed on the wired remote controller.
- (2) In some cases, a check code indicates multiple symptoms.
In this case, confirm LED display on the outdoor P.C. board to narrow the contents to be confirmed.
- (3) The check code on the remote controller is displayed only when the same trouble occurred continuously by multiple times while LED of the outdoor P.C. board displays even a trouble which occurred once.
Therefore the display on the remote controller may differ from that of LED.

How to check LED display on the outdoor P.C. board

[Service switch operation]

Currently occurring trouble indication

Even if only one of D800 to D804 is rapidly flashing then trouble has arisen. If any of D800 to D801 is slowly flashing or D805 is flashing then press and hold down SW01 and SW02 at the same time for at least 5 seconds.

D800 (YEL)	D801 (YEL)	D802 (YEL)	D803 (YEL)	D804 (YEL)	D805 (GRN)	
●	●	●	●	●	○	No trouble
◎	●	●	●	●	○	Trouble detected (Example. Discharge temp. trouble)

●: Go OFF, ○: Go ON, ◎: Flash (5 times/sec.)

Latest trouble indication

The following operation results in the latest trouble being indicated. It is retained in the memory and hence can be confirmed even when the power supply has been turned off. (Excluding outside air temperature sensor (TO) trouble)









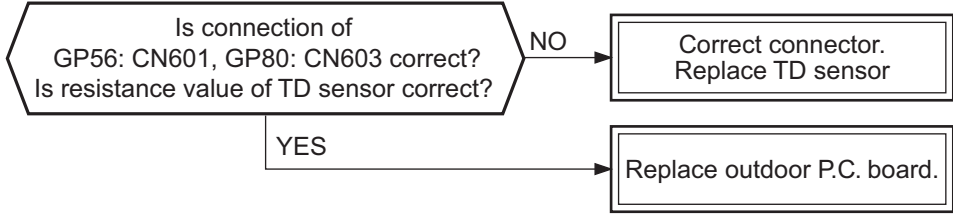

- 1) Confirm D800 to D804 are off (or rapidly flashing) and that D805 is lit up. If D800 to D804 are slowly flashing or D805 is flashing then push and hold down SW01 and SW02 at the same time for at least 5 seconds.
D800 to D804 will turn off (or be rapidly flashing) and D805 will change to flashing.
- 2) Push and hold down SW01 for at least 5 seconds. D804 will start slowly flashing.
- 3) Push SW01 several times until reaching the LED indication (D800 to D804) of 'Latest (including current) trouble indication'.
- 4) Push SW02. The latest trouble will be indicated.
- 5) Ensure to carry out step 1) to set the LEDs to the initial state (current occurring trouble) when finished and then exit.

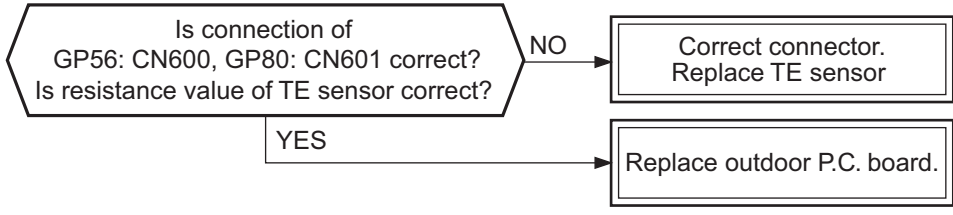

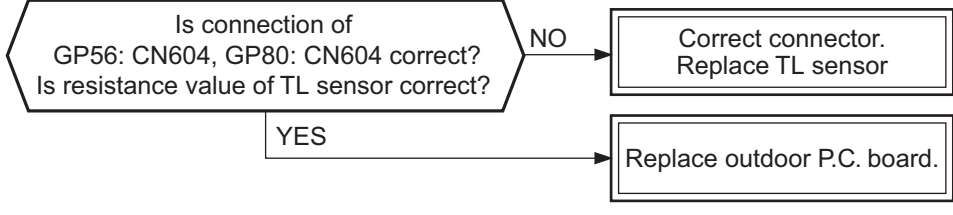
Latest (including current) trouble indication

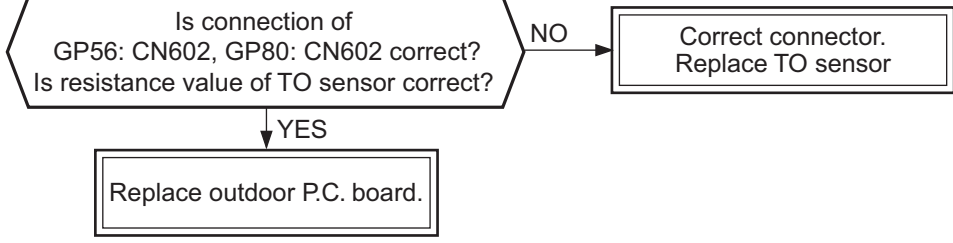
D800 (YEL)	D801 (YEL)	D802 (YEL)	D803 (YEL)	D804 (YEL)	D805 (GRN)
○	●	●	●	●	◎

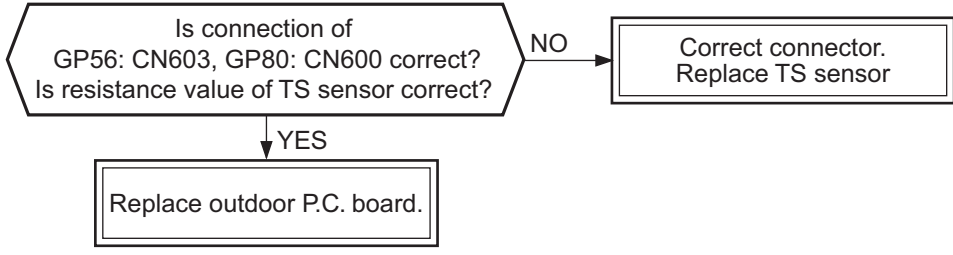
●: Go OFF, ○: Go ON, ◎: Flash (5 times/sec.)

Check code	Outdoor LED indication	Check and troubleshooting (Item without special mention indicates part of outdoor unit.)
[E04]	—	<p>[Indoor / Outdoor communication trouble]</p> <pre> graph TD Q1{{Is setting of group address of remote controller correct?}} -- NO --> A1[Check "check code [14]".] Q1 -- YES --> Q2{{Are inner wiring of indoor unit and inter-unit wires (1, 2, 3) correct?}} Q2 -- NO --> A2[Correct wiring and inter-unit wires.] Q2 -- YES --> Q3{{Are connection and wiring of terminal blocks (1, 2, 3) correct?}} Q3 -- NO --> A3[Correct wiring of connectors and terminal blocks.] Q3 -- YES --> A4[Replace control P.C. board.] </pre>

Check code	Outdoor LED indication	Check and troubleshooting (Item without special mention indicates part of outdoor unit.)
[F04]		<p data-bbox="432 304 839 331">[Discharge temp. sensor (TD) trouble]</p> <div data-bbox="432 342 1390 555">  <pre> graph TD Q1{Is connection of GP56: CN601, GP80: CN603 correct? Is resistance value of TD sensor correct?} Q1 -- NO --> A1[Correct connector. Replace TD sensor] Q1 -- YES --> A2[Replace outdoor P.C. board.] </pre> </div>
[F06]		<p data-bbox="432 580 900 607">[Heat exchanger temp. sensor (TE) trouble]</p> <div data-bbox="432 618 1390 831">  <pre> graph TD Q2{Is connection of GP56: CN600, GP80: CN601 correct? Is resistance value of TE sensor correct?} Q2 -- NO --> A3[Correct connector. Replace TE sensor] Q2 -- YES --> A4[Replace outdoor P.C. board.] </pre> </div>
[F07]		<p data-bbox="432 855 900 882">[Heat exchanger temp. sensor (TL) trouble]</p> <div data-bbox="432 893 1390 1106">  <pre> graph TD Q3{Is connection of GP56: CN604, GP80: CN604 correct? Is resistance value of TL sensor correct?} Q3 -- NO --> A5[Correct connector. Replace TL sensor] Q3 -- YES --> A6[Replace outdoor P.C. board.] </pre> </div>
[F08]		<p data-bbox="432 1128 815 1155">[Outside temp. sensor (TO) trouble]</p> <div data-bbox="432 1167 1390 1408">  <pre> graph TD Q4{Is connection of GP56: CN602, GP80: CN602 correct? Is resistance value of TO sensor correct?} Q4 -- NO --> A7[Correct connector. Replace TO sensor] Q4 -- YES --> A8[Replace outdoor P.C. board.] </pre> </div>
[F12]		<p data-bbox="432 1431 815 1458">[Suction temp. sensor (TS) trouble]</p> <div data-bbox="432 1469 1390 1722">  <pre> graph TD Q5{Is connection of GP56: CN603, GP80: CN600 correct? Is resistance value of TS sensor correct?} Q5 -- NO --> A9[Correct connector. Replace TS sensor] Q5 -- YES --> A10[Replace outdoor P.C. board.] </pre> </div>
[F13]		<p data-bbox="432 1744 831 1771">[Heat sink temp. sensor (TH) trouble]</p> <div data-bbox="432 1783 983 1886"> <p data-bbox="448 1783 967 1868">Replace outdoor P.C. board. * When replacing outdoor P.C. board, replace the fuse.</p> </div>



Check code	Outdoor LED indication	Check and troubleshooting (Item without special mention indicates part of outdoor unit.)
[F15]		<p>[Miswiring of heat exchanger sensor (TE, TS)]</p> <pre> graph TD Q1{{Is mounting status of TE and TS sensors correct?}} -- NO --> A1[Correct sensor mounting.] Q1 -- YES --> Q2{{Is connection of GP56: CN603, GP80: CN600 correct? Is resistance value of TS sensor correct?}} Q2 -- NO --> A2[Correct connector. Replace TS sensor] Q2 -- YES --> Q3{{Is connection of GP56: CN600, GP80: CN601 correct? Is resistance value of TE sensor correct?}} Q3 -- NO --> A3[Correct connector. Replace TE sensor] Q3 -- YES --> A4[Replace outdoor P.C. board.] </pre>
[F31]		<p>[EEPROM trouble]</p> <p>Replace outdoor P.C. board.</p>
[H01]		<p>[Compressor break down]</p> <pre> graph TD Q1{{Is power supply voltage normal? AC198 to 264 V}} -- NO --> A1[Correct power supply line.] Q1 -- YES --> Q2{{Is wire connection correct? Compressor lead wires (P.C. board side, Compressor side), Reactor lead wires, Power supply lead wires}} Q2 -- NO --> A2[Check wire connection and correct it.] Q2 -- YES --> Q3{{Does an abnormal overload happen?}} Q3 -- NO --> A3[Remove and improve the cause of overload.] Q3 -- YES --> A4[Replace outdoor P.C. board. * When replacing outdoor P.C. board, replace the fuse.] </pre>

Check code	Outdoor LED indication	Check and troubleshooting (Item without special mention indicates part of outdoor unit.)
[H02]	●●○○●○	<p>[Compressor lock]</p> <pre> graph TD Q1{{Is power supply voltage normal? (AC198 to 264 V)}} -- NO --> A1[Correct power supply line.] Q1 -- YES --> Q2{{Is wire connection correct? Compressor lead wires (P.C. board side, Compressor side), Reactor lead wires, Power supply lead wires}} Q2 -- NO --> A2[Check wire connection and correct it.] Q2 -- YES --> Q3{{Is compressor under correct conditions?}} Q3 -- YES --> A3[Replace outdoor P.C. board. * When replacing outdoor P.C. board, replace the fuse.] Q3 -- NO --> Q4{{Is there refrigerant stagnation?}} Q4 -- NO --> A4[Compressor lock → Replace] Q4 -- YES --> Q5{{Does PMV correctly operate?}} Q5 -- NO --> A5[Replace TE, TS sensors and PMV. Malfunction → Replace] Q5 -- YES --> A3 </pre>
[H03]	○○●○○●○	<p>[Current detection circuit trouble]</p> <p>Replace outdoor P.C. board.</p>
[H04]	●○○○○●○	<p>[Case thermostat operation]</p> <pre> graph TD Q1{{Are GP56: CN500, GP80: CN609 connection and case thermostat correct?}} -- NO --> A1[Correct connector. Case thermostat trouble → Replace] Q1 -- YES --> Q2{{When short-circuit the case thermostat, can you perform the cooling / heating operation?}} Q2 -- NO --> A2[Replace outdoor P.C. board. * When replacing outdoor P.C. board, replace the fuse.] Q2 -- YES --> Q3{{Is there gas leak? Is there refrigerant shortage?}} Q3 -- YES --> A3[Malfunction part repair. Recharge refrigerant.] Q3 -- NO --> Q4{{Is service valve fully opened?}} Q4 -- NO --> A4[Open service valve fully.] Q4 -- YES --> Q5{{Is PMV normal?}} Q5 -- NO --> A5[Replace the PMV.] Q5 -- YES --> A6[Check crushed or broken pipe. Malfunction part repair] </pre>

Check code	Outdoor LED indication	Check and troubleshooting (Item without special mention indicates part of outdoor unit.)
[L10]	●●●●○	<p>[Heat sink temp. sensor (TH) trouble]</p> <div style="border: 1px solid black; padding: 5px; width: fit-content;">Cut jumper line according to the explanation sheet packaged with the service P.C. board.</div>
[L29]	○●●●○	<p>[Communication trouble MCUs]</p> <div style="border: 1px solid black; padding: 5px; width: fit-content;">Replace outdoor P.C. board</div>
[P03]	○●●●●	<p>[Discharge temp. trouble]</p> <pre> graph TD Q1{Is there gas leak? Is there refrigerant shortage?} -- YES --> A1[Malfunction part repair. Recharge refrigerant.] Q1 -- NO --> Q2{Is PMV normal?} Q2 -- NO --> A2[Replace the PMV.] Q2 -- YES --> Q3{Does an abnormal overload happen?} Q3 -- YES --> A3[Remove and improve the cause of overload.] Q3 -- NO --> Q4{Is connection of GP56: CN601, GP80: CN603 correct? Is resistance value of TL sensor correct?} Q4 -- NO --> A4[Replace TD sensor.] Q4 -- YES --> A5[Replace outdoor P.C. board.] </pre>
[P05]	●●○●○	<p>[Power supply trouble] Voltage failure</p> <pre> graph TD Q1{Check the same items as [P04] trouble.} --> Q2{Is power supply voltage normal? (AC198 to 264 V)?} Q2 -- NO --> A1[Confirmation of electrical work etc.] Q2 -- YES --> A2[Replace outdoor P.C. board.] </pre>

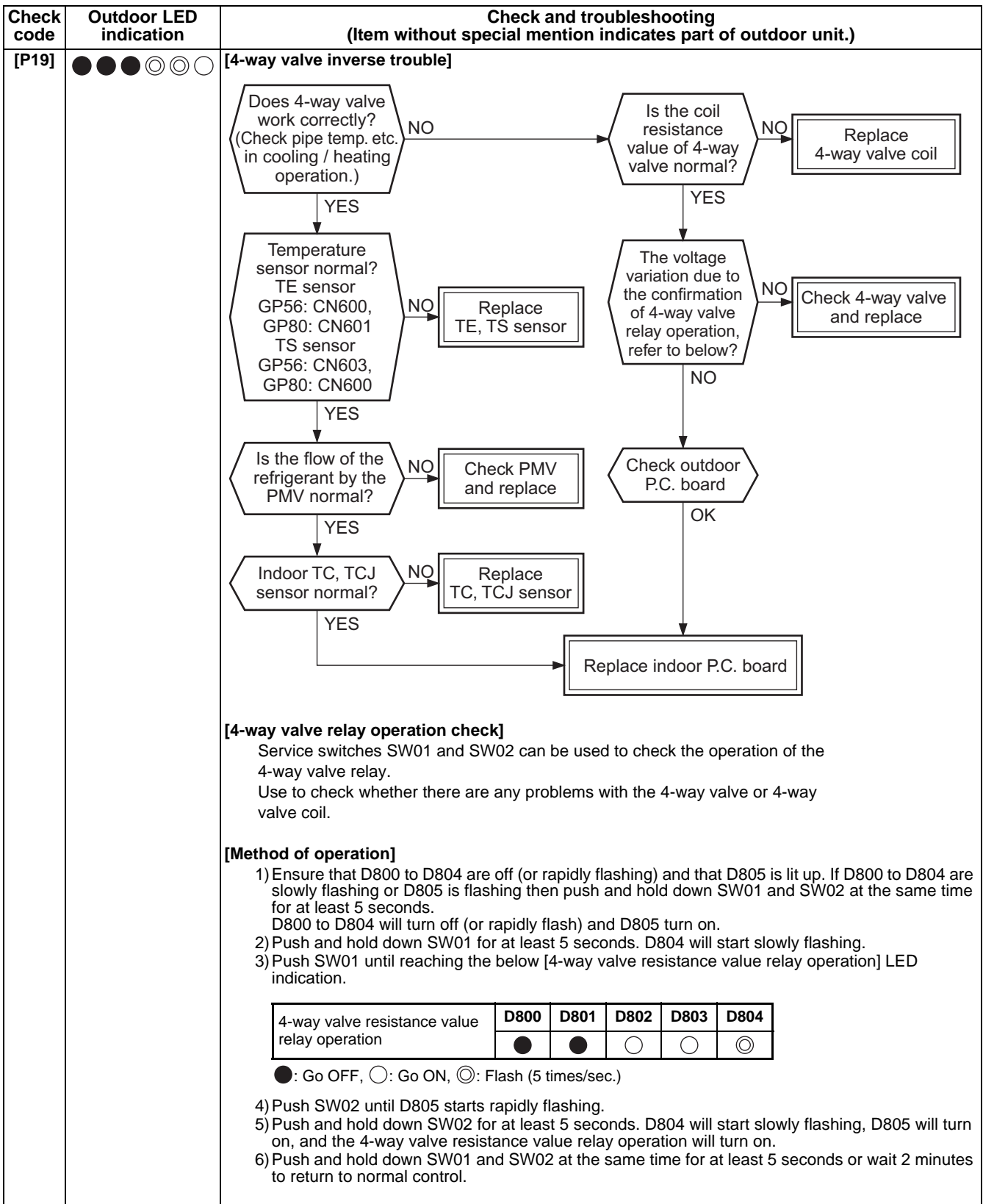
Check code	Outdoor LED indication	Check and troubleshooting (Item without special mention indicates part of outdoor unit.)
[P07]	●○○●○○○	<p>[Heat sink overheating trouble]</p> <pre> graph TD Q1{Are radiation grease properly applied? Is the screw stop of the motor drive element IC200 on the outdoor P.C. board, the sub heat sink, and the diode bridge tightened correctly?} A1[Apply radiation grease to objective, retightening of screw] Q2{Does something block the ventilation around the heatsink? Does something block air flow from the fan? (Short-circuit etc.)} A2[Remove blocking matter, Short-circuit improvement] A3[Replace outdoor P.C. board. * When replacing outdoor P.C. board, replace the fuse.] Q1 -- NO --> A1 Q1 -- YES --> Q2 Q2 -- YES --> A2 Q2 -- NO --> A3 </pre>
[P15]	○○○●○○○	<p>[Gas leak detection]</p> <pre> graph TD Q1{Is there gas leak? Is there refrigerant shortage?} A1[Malfunction part repair. Recharge refrigerant.] Q2{Is PMV normal?} A2[Replace the PMV.] Q3{Is service valve fully opened?} A3[Open service valve fully.] Q4{Is there crushed pipe?} A4[Correct and replace piping.] Q5{Check temp. sensor. TD sensor GP56: CN601, GP80: CN603 TS sensor GP56: CN603, GP80: CN600} A5[Correct connector. Sensor trouble -> Replace] A6[Replace outdoor P.C. board.] Q1 -- YES --> A1 Q1 -- NO --> Q2 Q2 -- NO --> A2 Q2 -- YES --> Q3 Q3 -- NO --> A3 Q3 -- YES --> Q4 Q4 -- YES --> A4 Q4 -- NO --> Q5 Q5 -- Abnormality --> A5 Q5 -- OK --> A6 </pre>



Check code	Outdoor LED indication	Check and troubleshooting (Item without special mention indicates part of outdoor unit.)
[P20]		<p>[High pressure protective operation]</p>
[P04]		<p>Is service valve fully opened?</p> <p>NO → Open service valve fully.</p> <p>YES → Reset the power supply and then perform test run matching to the season.</p> <p>Cooling season Cooling operation</p> <p>Is resistance value of TE sensor correct? (Resistance value measurement)</p> <p>NO → Replace TE sensor.</p> <p>YES → Are the outdoor fan appearance and screw tightening normal?</p> <p>NO → Check outdoor fan. Failure → Replace, retightening</p> <p>YES → Does the outdoor fan normally operate ?</p> <p>NO → Check the same items as [P22] trouble.</p> <p>YES → Are the following items for outdoor units correct? • Clogging of heat exchanger • Short-circuit (Air flow)</p> <p>NO → Eliminate interfering element.</p> <p>YES → Check overcharge of refrigerant, clogging of cycle, broken pipe, abnormal overload, etc. Malfunction part repair.</p> <p>Heating season Heating operation</p> <p>Does indoor fan operate correctly?</p> <p>NO → Are indoor fan motor an connector correct?</p> <p>NO → Malfunction part repair</p> <p>YES → Are resistance values of indoor TC and TCJ sensors normal?</p> <p>NO → Replace TC, TCJ sensor.</p> <p>YES → Replace indoor P.C. board.</p> <p>Are the following items for indoor units correct? • Choking up the filter • Clogging of heat exchanger • Short-circuit (Air flow)</p> <p>NO → Eliminate interfering element.</p> <p>YES → Check overcharge of refrigerant, clogging of cycle, broken pipe, abnormal overload, etc. Malfunction part repair.</p>

Check code	Outdoor LED indication	Check and troubleshooting (Item without special mention indicates part of outdoor unit.)												
[P22]	● ○ ● ○ ○ ○ ○	<p>[Fan system trouble]</p> <pre> graph TD Q1{{Is power supply voltage normal? AC198 to 264 V}} -- NO --> A1[Check wiring construction. Ask repair of power supply.] Q1 -- YES --> Q2{{Rotate shaft of the fan motor by hands during power-OFF. Can it rotate smoothly? Is coil resistance of fan motor correct? Between red and white lead wire: 12 to 20 Ω Between white and black lead wire: 12 to 20 Ω Between black and red lead wire: 12 to 20 Ω}} Q2 -- NO --> A2[Replace fan motor.] Q2 -- YES --> Q3{{Is the fuse normal? (Near the terminal block)}} Q3 -- NO --> A3[Replace fuse.] Q3 -- YES --> A4[Replace outdoor P.C. board] </pre> <p>[Confirmation of independent operation of outdoor fan] Service switches SW01 and SW02 can be used to check the operation of the 4-way valve relay. Use to check whether there are any problems with the 4-way valve or 4-way valve coil.</p> <p>[Method of operation]</p> <ol style="list-style-type: none"> 1) Ensure that D800 to D804 are off (or rapidly flashing) and that D805 is lit up. If D800 to D804 are slowly flashing or D805 is flashing then please push and hold down SW01 and SW02 at the same time for at least 5 seconds. D800 to D804 will turn off (or rapidly flash) and D805 turn on. 2) Push and hold down SW01 for at least 5 seconds. D804 will start slowly flashing. 3) Push SW01 until reaching the below [Confirmation of independent operation of outdoor fan] LED indication. <table border="1" data-bbox="496 1256 1179 1335"> <thead> <tr> <th>Confirmation of independent operation of outdoor fan</th> <th>D800</th> <th>D801</th> <th>D802</th> <th>D803</th> <th>D804</th> </tr> </thead> <tbody> <tr> <td></td> <td>○</td> <td>○</td> <td>●</td> <td>○</td> <td>◎</td> </tr> </tbody> </table> <p>●: Go OFF, ○: Go ON, ◎: Flash (5 times/sec.)</p> <ol style="list-style-type: none"> 4) Push SW02 until D805 starts rapidly flashing. 5) Push and hold down SW02 for at least 5 seconds. D804 will start slowly flashing, D805 will turn on, and fan will start operation. 6) Push and hold down SW01 and SW02 at the same time for at least 5 seconds or wait 2 minutes until fan operation stops. <p>* If any unclear point arises during an operation then can return to step 1 by pressing and holding down SW01 and SW02 at the same time for at least 5 seconds.</p>	Confirmation of independent operation of outdoor fan	D800	D801	D802	D803	D804		○	○	●	○	◎
Confirmation of independent operation of outdoor fan	D800	D801	D802	D803	D804									
	○	○	●	○	◎									
[P26]	○ ○ ● ○ ○ ○ ○	<p>[Short-circuit of compressor drive element]</p> <pre> graph TD Q1{{Are connections of compressor lead wires and reactor correct? (Check referring to the Wiring diagram.)}} -- NO --> A1[Correct wiring.] Q1 -- YES --> Q2{{Does the same trouble occur in operation without compressor lead wires?}} Q2 -- YES --> A2[Replace outdoor P.C. board.] Q2 -- NO --> A3[Check compressor. (Layer short, etc.) Malfunction → Replace] </pre>												

Check code	Outdoor LED indication	Check and troubleshooting (Item without special mention indicates part of outdoor unit.)
[P29]	●●○○○○	<p data-bbox="430 302 805 331">[Position detection circuit trouble]</p> <div data-bbox="443 344 983 443" style="border: 1px solid black; padding: 5px;"> <p data-bbox="450 353 746 383">Replace outdoor P.C. board.</p> <p data-bbox="450 383 959 434">* When replacing outdoor P.C. board, replace the fuse.</p> </div>
— No code	○○●○○○	<p data-bbox="430 470 1182 499">[Other trouble] --- Compressor step-out from sudden changes in load etc.</p> <p data-bbox="430 499 1382 528">* Outdoor LED indication occurs but it automatically restarts and does not confirm any trouble.</p> <p data-bbox="430 528 1233 557">* May occur also when the compressor is open phase and wiring disconnected.</p>

Temperature sensor

Temperature – Resistance value characteristic table

TA, TC, TCJ, TE, TS, TO sensors

Representative value

Temperature (°C)	Resistance value (kΩ)		
	(Minimum value)	(Standard value)	(Maximum value)
0	32.33	33.80	35.30
10	19.63	20.35	21.09
20	12.23	12.59	12.95
25	9.75	10.00	10.25
30	7.764	7.990	8.218
40	5.013	5.192	5.375
50	3.312	3.451	3.594
60	2.236	2.343	2.454
70	1.540	1.623	1.709
80	1.082	1.146	1.213
90	0.7740	0.8237	0.8761
100	0.5634	0.6023	0.6434

TD, TL sensors

Representative value

Temperature (°C)	Resistance value (kΩ)		
	(Minimum value)	(Standard value)	(Maximum value)
0	150.5	161.3	172.7
10	92.76	99.05	105.6
20	58.61	62.36	66.26
25	47.01	49.93	52.97
30	37.93	40.22	42.59
40	25.12	26.55	28.03
50	17.00	17.92	18.86
60	11.74	12.34	12.95
70	8.269	8.668	9.074
80	5.925	6.195	6.470
90	4.321	4.507	4.696
100	3.205	3.336	3.468

TA, TC, TCJ, TE, TS, TO sensors

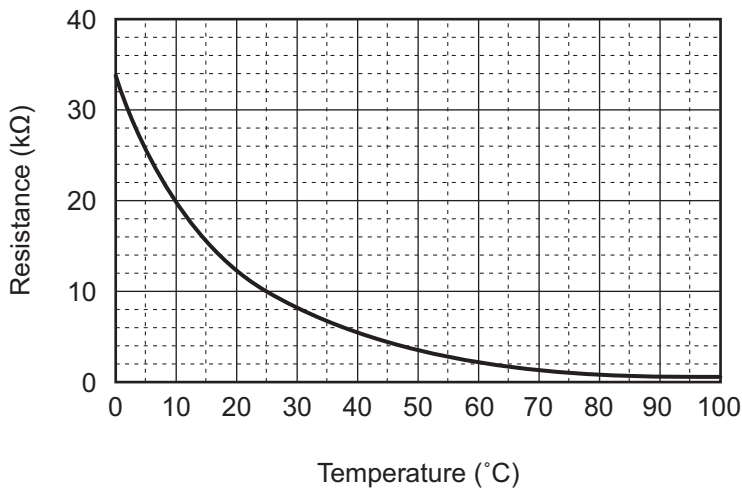

TD, TL sensors

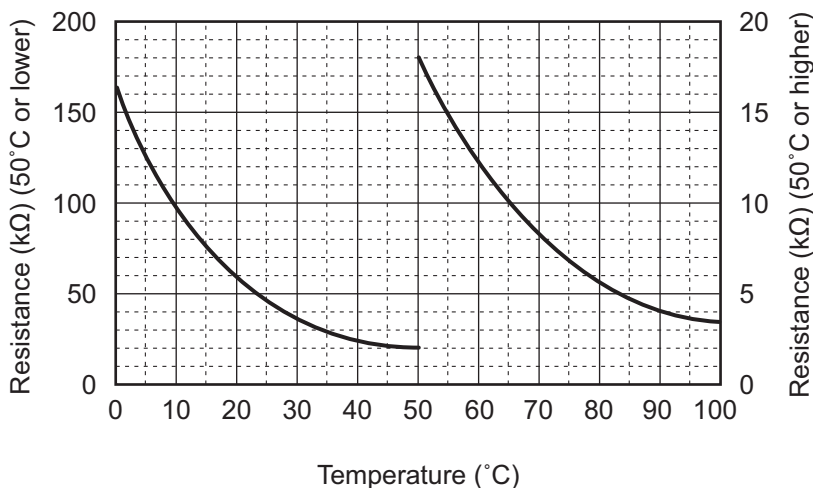

Pressure sensor I/O wire connecting table

Pin No.	Input / Output name	Lead wire
1	—	—
2	OUTPUT	White
3	GND	Black
4	DC5 V	Red

* As TH sensor (Outdoor unit heat sink temp. sensor) is incorporated in the outdoor control P.C. board, the resistance value cannot be measured.

9 SETUP AT LOCAL SITE AND OTHERS

9-1. Calling of Check code History

<Contents>

The trouble contents in the past can be called.

<Procedure>

- 1** Push **SET** + **TEST** buttons simultaneously for 4 seconds or more to call the service check mode.
 Service check goes on, the CODE No. **01** is displayed, and then the content of the latest alarm is displayed.
 The number and trouble contents of the indoor unit in which a trouble occurred are displayed.
- 2** In order to monitor another check code history, push the set temperature **TEMP.** buttons to change the check code history No. (CODE No.).
CODE No. 01 (Latest) → CODE No. 04 (Old).
 NOTE: 4 check code histories are stored in memory.
- 3** Pushing **TEST** button returns the display to usual display.

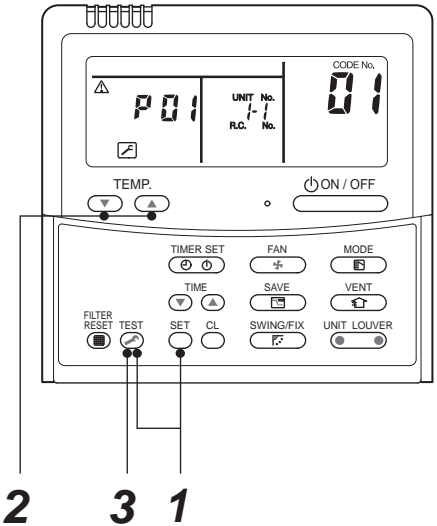

<Operation procedure>

1 → 2 → 3

↑
Returned to usual display

REQUIREMENT

Do not push **CL** button, otherwise all the check code histories of the indoor unit are deleted.

Indoor unit power-ON sequence

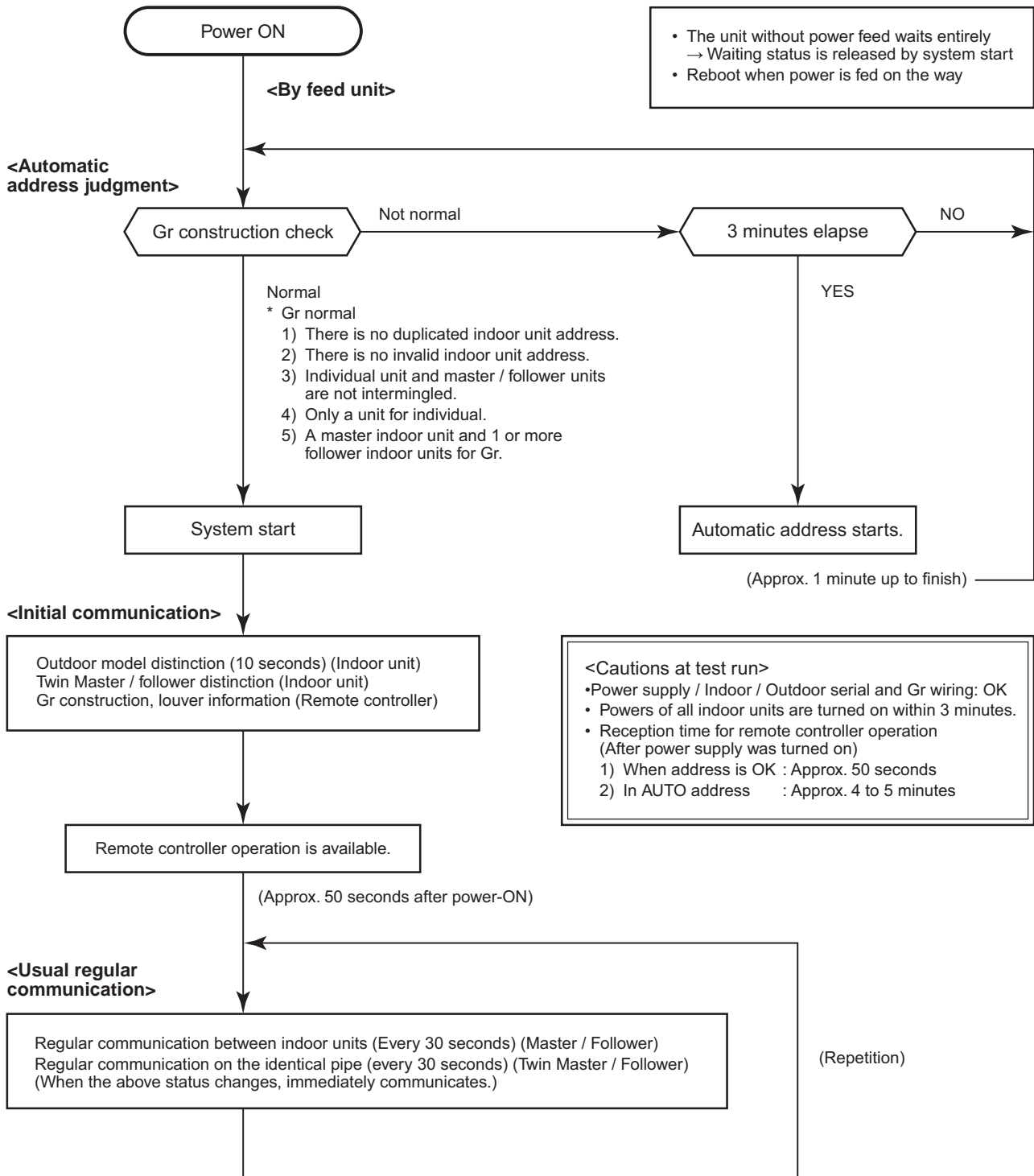

- In a group operation, if the indoor unit which was fed power after judgment of automatic address cannot receive regular communication from the master unit and regular communication on identical pipe within 120 seconds after power was turned on, it reboots (system reset).

→ The operation starts from judgment of automatic address (Gr construction check) again.

(If the address of the master unit was determined in the previous time, the power fed to the master unit and reboot works, the master unit may change though the indoor unit line address is not changed.)

9-2. Outdoor Unit

Various status displays and operations can be accessed using the push buttons (service switches) on the outdoor Control P.C. board and LED display.

Service switch (SW01 and SW02) operation

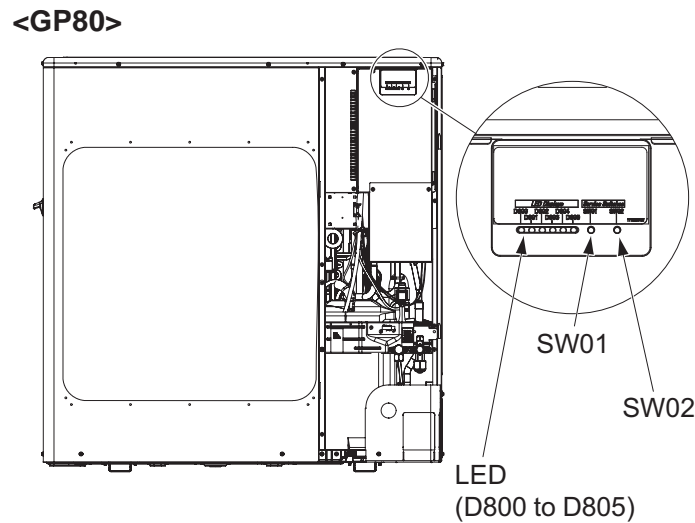
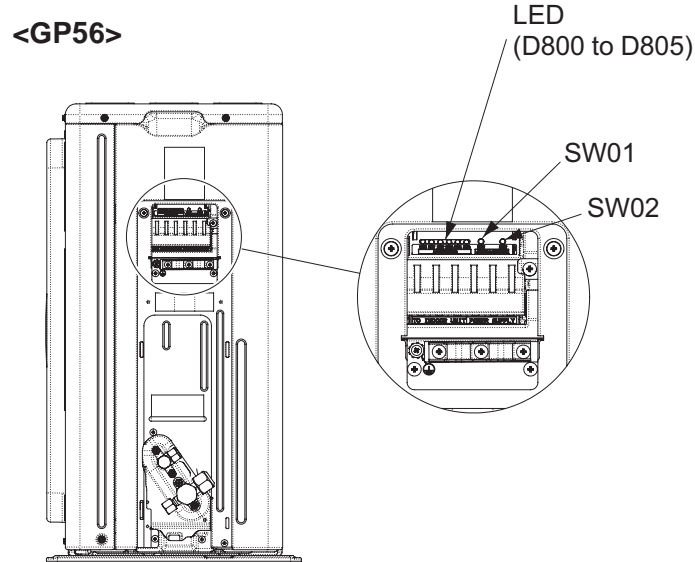

Concerning the LED display

- The LED display has 4 patterns.
 - : Go ON ● : Go OFF ◎ : flash (5 times/sec.) ◇ : flashing (1 time/sec.)
- The initial state of the LED display is as shown on the right with D805 lit up. If not in the initial state (D805 flashing) then it can be returned to the initial state by pushing and holding down SW01 and SW02 at the same time for 5 seconds.

LED display: Initial state

D800 to D804 : Go Off and flash (5 times/sec.)
 D805 : Go ON

	D800	D801	D802	D803	D804	D805
LED	○ (Yellow)	○ (Yellow)	○ (Yellow)	○ (Yellow)	○ (Yellow)	○ (Green)

1. Various settings available via the outdoor unit (Existing pipe, Maximum frequency change, Snow guard fan control, Cooling only setup, etc.)

(1) Service switch setting

Various settings can be made using the service switches.

[Method of operation]

- 1) Ensure the LED display shows the initial status. If not then ensure to restore the initial status.
- 2) Press SW01 for at least 5 seconds. D804 will start slowly flashing.
- 3) Push SW01 several times until reaching the required LED display function.

Functions	LED display	Control content																													
Existing pipe setting	<table border="1"> <tr> <td>D800</td> <td>D801</td> <td>D802</td> <td>D803</td> <td>D804</td> </tr> <tr> <td>●</td> <td>●</td> <td>○</td> <td>●</td> <td>◎</td> </tr> </table>	D800	D801	D802	D803	D804	●	●	○	●	◎	Activate when existing DIA 19.1 piping is used. Note that in this case, depending on the outdoor and indoor air temperature, the heating capacity may drop.																			
D800	D801	D802	D803	D804																											
●	●	○	●	◎																											
Cooling only setting	<table border="1"> <tr> <td>D800</td> <td>D801</td> <td>D802</td> <td>D803</td> <td>D804</td> </tr> <tr> <td>○</td> <td>○</td> <td>●</td> <td>●</td> <td>◎</td> </tr> </table>	D800	D801	D802	D803	D804	○	○	●	●	◎	Cooling only setting. (Can also be changed using the DN code [0F] on the wired remote control.)																			
D800	D801	D802	D803	D804																											
○	○	●	●	◎																											
Snow guard fan control	<table border="1"> <tr> <td>D800</td> <td>D801</td> <td>D802</td> <td>D803</td> <td>D804</td> </tr> <tr> <td>●</td> <td>○</td> <td>●</td> <td>●</td> <td>◎</td> </tr> </table>	D800	D801	D802	D803	D804	●	○	●	●	◎	The snow guard fan control enables snow to be diverted from the path of the fan and heat exchanger, thereby protecting the fan motor. And even when the compressor is not in use but the external temperature is less than 7°C ensure the outdoor fan is going using W3.																			
D800	D801	D802	D803	D804																											
●	○	●	●	◎																											
Maximum frequency change	<table border="1"> <tr> <td>D800</td> <td>D801</td> <td>D802</td> <td>D803</td> <td>D804</td> </tr> <tr> <td>●</td> <td>●</td> <td>●</td> <td>○</td> <td>◎</td> </tr> </table>	D800	D801	D802	D803	D804	●	●	●	○	◎	<p>Enable this if you wish to lower the maximum compressor frequency. It will lower the maximum frequency during both cooling and heating. Note however it does reduce the maximum capacity.</p> <p>Maximum compressor frequency (rps)</p> <table border="1"> <thead> <tr> <th rowspan="2">Model</th> <th colspan="2">GP56</th> <th colspan="2">GP80</th> </tr> <tr> <th>Cooling</th> <th>Heating</th> <th>Cooling</th> <th>Heating</th> </tr> </thead> <tbody> <tr> <td>Standard status</td> <td>76.2</td> <td>105.6</td> <td>80.4</td> <td>99.6</td> </tr> <tr> <td>When setting is</td> <td>76.2</td> <td>95.4</td> <td>74.4</td> <td>74.4</td> </tr> </tbody> </table>	Model	GP56		GP80		Cooling	Heating	Cooling	Heating	Standard status	76.2	105.6	80.4	99.6	When setting is	76.2	95.4	74.4	74.4
D800	D801	D802	D803	D804																											
●	●	●	○	◎																											
Model	GP56		GP80																												
	Cooling	Heating	Cooling	Heating																											
Standard status	76.2	105.6	80.4	99.6																											
When setting is	76.2	95.4	74.4	74.4																											

○ : Go ON ● : Go OFF ◎ : Flash (5 times/sec.)

- 4) Push SW01 until D805 starts rapidly flashing.
 - 5) Press and hold down SW02 for at least 5 seconds. D804 will start slowly flashing and D805 will light up, and the various settings will take effect.
 - 6) To make more settings repeat steps 3) to 5).
 - 7) To invalidate any settings made in steps 1 to 3 press SW01 to turn off D805.
 - 8) Press and hold down SW02 for at least 5 seconds. D804 will start to slowly flash and D805 will turn off and the various settings will be invalidated.
- *If any unclear point arises during an operation then can return to step 1 by pressing and holding down SW01 and SW02 at the same time for at least 5 seconds.

Various settings confirmation method

Whether the various settings are in effect or not can be confirmed.

- 1) Ensure the LED display shows the initial status. If not then ensure to restore the initial status.
- 2) Push SW01 for at least 5 seconds. D804 will start slowly flashing.
- 3) Push SW01 several times until reaching the desired function on the LED display. If the setting is valid D804 and D805 will rapidly flash. (If the setting is invalid then D804 will rapidly flash but D805 will turn off.)
- 4) Push and hold down SW01 and SW02 at the same time for at least 5 seconds to return the LED display to the initial state.

Returning to the factory default settings

The factory default settings can be restored using the following procedure.

- 1) Ensure the LED display shows the initial state. If not then ensure to return it to the initial state.
- 2) Push and hold down SW01 for at least 5 seconds and confirm that D804 is slowly flashing.
- 3) Push SW01 several times until reaching the LED display (D800 to D805) shown on the right or 'Returning to the default factory setting LED display'.
- 4) Push and hold down SW02 for at least 5 seconds and confirm that D804 is slowly flashing.
- 5) Push and hold down SW01 and SW02 at the same time for at least 5 seconds to return to the initial state LED display.

Return to default factory setting LED display					
D800	D801	D802	D803	D804	D805
●	●	●	●	○	●
○ : Go ON ● : Go OFF ○ : Flash (5 times/sec.)					

Sub-P.C. board switch and LED arrangement diagram

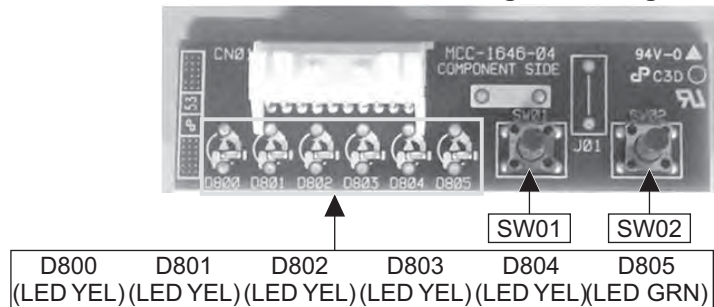

2. Service support functions (LED display and switch operation)

(1) LED display switching (SW01 and SW02 operation)

(1)-1. Display switch list

Service switches SW01 and SW02 can be used to change the display content of LEDs D800 to D805 on the outdoor unit.

[Method of operation]

- 1) Ensure the LED display shows the initial state. If not then ensure to return it to the initial state.
- 2) Push SW01 several times until reaching the desired display item.

LED display						Control content
D800	D801	D802	D803	D804	D805	Trouble indication (Current trouble). Displays the current trouble. Will not appear if no trouble has occurred. (Refer to (1)-2-1.)
●	●	●	●	●	◎	
D800	D801	D802	D803	D804	D805	Trouble indication (Latest trouble: latest and including current trouble). Previous trouble can be checked using this setting, for example, after previous trouble has been resolved (and even after the power has been turned off). * If trouble is currently occurring then the same content will be displayed. * TO sensor trouble only and thus this setting does not display. (Check using the current trouble setting). (Refer to (1)-2-2.)
○	●	●	●	●	◎	
D800	D801	D802	D803	D804	D805	Discharge temperature sensor (TD) indication. Displays the discharge temperature sensor (TD) value. (Refer to (1)-3.)
●	○	●	●	●	◎	
D800	D801	D802	D803	D804	D805	Outdoor heat exchanger temperature sensor (TE) indication. Displays the outdoor heat exchanger temperature sensor (TE) value. (Refer to (1)-3.)
○	○	●	●	●	◎	
D800	D801	D802	D803	D804	D805	Outdoor heat exchanger temperature sensor (TL) indication. Displays the outdoor heat exchanger sensor (TL) value. (Refer to (1)-3.)
●	○	○	●	●	◎	
D800	D801	D802	D803	D804	D805	Inlet temperature sensor (TS) indication. Displays the inlet temperature sensor (TS) value. (Refer to (1)-3.)
●	●	○	●	●	◎	
D800	D801	D802	D803	D804	D805	Outdoor external temperature sensor (TO) indication. Displays the outdoor external temperature sensor (TO) value. (Refer to (1)-3.)
○	●	○	●	●	◎	
D800	D801	D802	D803	D804	D805	Heat sink temperature sensor (TH) indication. Displays the heat sink temperature sensor (TH) value. (Refer to (1)-3.)
○	○	○	●	●	◎	
D800	D801	D802	D803	D804	D805	Current indication. Displays the outdoor unit current value. (Refer to (1)-3.)
○	●	●	○	●	◎	
D800	D801	D802	D803	D804	D805	Compressor operation frequency indication. Displays the operating frequency of the compressor. (Refer to (1)-3.)
●	○	●	○	●	◎	
D800	D801	D802	D803	D804	D805	PMV opening indication. Displays the degree to which the PMV is open. (Refer to (1)-3.)
○	○	●	○	●	◎	
D800	D801	D802	D803	D804	D805	Indoor room air temperature sensor (TA) indication. Displays the indoor room air temperature sensor (TA) value. (Refer to (1)-3.)
●	●	○	○	●	◎	
D800	D801	D802	D803	D804	D805	Indoor heat exchange temperature sensor (TC) indication. Displays the indoor heat exchange temperature sensor (TC) value. (Refer to (1)-3.)
○	●	○	○	●	◎	
D800	D801	D802	D803	D804	D805	Indoor heat exchanger sensor (TCJ) indication. Displays the indoor heat exchanger sensor (TCJ) value. (Refer to (1)-3.)
●	○	○	○	●	◎	
D800	D801	D802	D803	D804	D805	Refrigerant leak indication. Displays if a certain amount of refrigerant has leaked. (Refer to (1)-4.)
●	●	●	○	●	◎	

○: Go ON ●: Go OFF ◎: Flash (5 times/sec.)

- 3) Push SW02 to switch to the desired display item.
- 4) To access the other display items repeat steps 1) to 3).
- 5) Before exiting ensure to perform step 1) and set the LED to the initial state (current abnormality indication).

(1)-2. Trouble display

Current and the latest trouble (latest and including the present trouble) can be checked using the lighting status of the LEDs D800 to D805 on the outdoor unit.

(1)-2-1. Current trouble indication

LED indication						Name of trouble	Wired remote controller check code
D800	D801	D802	D803	D804	D805		
●	●	●	●	●	○	Normal	—
○	●	●	●	●	○	Discharge temp. sensor (TD) trouble	F04
●	○	●	●	●	○	Heat exchanger temp. sensor (TE) trouble	F06
○	○	●	●	●	○	Heat exchanger temp. sensor (TL) trouble	F07
●	●	○	●	●	○	Outside temp. sensor (TO) trouble	F08
○	●	○	●	●	○	Suction temp. sensor (TS) trouble	F12
●	○	○	●	●	○	Heat sink temp. sensor (TH) trouble	F13
○	○	○	●	●	○	Miss-mounting of sensor (TE, TS)	F15
●	○	●	○	●	○	EEPROM trouble	F31
○	○	●	○	●	○	Compressor break down	H01
●	●	○	○	●	○	Compressor lock	H02
○	●	○	○	●	○	Current detection circuit trouble	H03
●	○	○	○	●	○	Case thermostat operation	H04
●	●	●	●	○	○	Unset model type	L10
○	●	●	●	○	○	Communication trouble between MCUs	L29
●	○	●	●	○	○	Discharge temp. sensor trouble	P03
○	○	●	●	○	○	High pressure SW operation	P04
●	●	○	●	○	○	Power supply trouble	P05
●	○	○	●	○	○	Heat sink overheat trouble	P07
○	○	○	●	○	○	Gas leak detection	P15
●	●	●	○	○	○	4-way valve reversal trouble	P19
○	●	●	○	○	○	High pressure protective operation	P20
●	○	●	○	○	○	Fan system trouble	P22
○	○	●	○	○	○	Short-circuit of compressor drive element	P26
●	●	○	○	○	○	Position detection circuit trouble	P29

○: Go ON ●: Go OFF ○: Flash (5 times/sec.)

(1)-2-2. Latest (including current) trouble indication

LED indication						Name of trouble
D800	D801	D802	D803	D804	D805	
●	●	●	●	●	◇	Normal
○	●	●	●	●	◇	Discharge temp. sensor (TD) trouble
●	○	●	●	●	◇	Heat exchanger temp. sensor (TE) trouble
○	○	●	●	●	◇	Heat exchanger temp. sensor (TL) trouble
●	●	○	●	●	◇	Outside temp. sensor (TO) trouble
○	●	○	●	●	◇	Suction temp. sensor (TS) trouble
●	○	○	●	●	◇	Heat sink temp. sensor (TH) trouble
○	○	○	●	●	◇	Miswiring of heat exchanger temp. sensor (TE, TS)
●	○	●	○	●	◇	EEPROM trouble
○	○	○	○	●	◇	Compressor break down
●	●	○	○	●	◇	Compressor lock
○	●	○	○	●	◇	Current detection circuit trouble
●	○	○	○	●	◇	Case thermostat operation
●	●	●	●	○	◇	Unset model type
○	●	●	●	○	◇	Communication trouble between MCUs
●	○	●	●	○	◇	Discharge temp. sensor trouble
○	○	●	●	○	◇	High pressure SW operation
●	●	○	●	○	◇	Power supply trouble
●	○	○	●	○	◇	Heat sink overheat trouble
○	○	○	●	○	◇	Gas leak detection
●	●	●	○	○	◇	4-way valve reversal trouble
○	●	●	○	○	◇	High pressure protective operation
●	○	●	○	○	◇	Fan system trouble
○	○	●	○	○	◇	Short-circuit of compressor drive element
●	●	○	○	○	◇	Position detection circuit trouble

○: Go ON ●: Go OFF ○: Flash (5 times/sec.) ◇: flashing (1 time/sec.)

(1)-3. Sensor, current, compressor operation frequency, PMV opening indication

Interface (CDB) P.C. board detected values (for example temperature and current sensor values) can be easily checked.

*Temperature sensors TD, TE, TL, TS, TO, TH, TA, TC, TCJ

*Current..... Current sensor (CT) value detected

LED indication						Temperature sensor (°C)	Current (A)	Compressor frequency (rps)	Degree of PMV opening (pls)
D800 (YEL)	D801 (YEL)	D802 (YEL)	D803 (YEL)	D804 (YEL)	D805 (GRN)				
●	●	●	●	●	◇	Less than -25	0 ~	0 ~	0 ~ 19
○	●	●	●	●	◇	-25 ~	1 ~	5 ~	20 ~ 39
●	○	●	●	●	◇	-20 ~	2 ~	10 ~	40 ~ 59
○	○	●	●	●	◇	-15 ~	3 ~	15 ~	60 ~ 79
●	●	○	●	●	◇	-10 ~	4 ~	20 ~	80 ~ 99
○	●	○	●	●	◇	-5 ~	5 ~	25 ~	100 ~ 119
●	○	○	●	●	◇	0 ~	6 ~	30 ~	120 ~ 139
○	○	○	●	●	◇	5 ~	7 ~	35 ~	140 ~ 159
●	●	●	○	●	◇	10 ~	8 ~	40 ~	160 ~ 179
○	●	●	○	●	◇	15 ~	9 ~	45 ~	180 ~ 199
●	○	●	○	●	◇	20 ~	10 ~	50 ~	200 ~ 219
○	○	●	○	●	◇	25 ~	11 ~	55 ~	220 ~ 239
●	●	○	○	●	◇	30 ~	12 ~	60 ~	240 ~ 259
○	●	○	○	●	◇	35 ~	13 ~	65 ~	260 ~ 279
●	○	○	○	●	◇	40 ~	14 ~	70 ~	280 ~ 299
○	○	○	○	●	◇	45 ~	15 ~	75 ~	300 ~ 319
●	●	●	●	○	◇	50 ~	16 ~	80 ~	320 ~ 339
○	●	●	●	○	◇	55 ~	17 ~	85 ~	340 ~ 359
●	○	●	●	○	◇	60 ~	18 ~	90 ~	360 ~ 379
○	○	●	●	○	◇	65 ~	19 ~	95 ~	380 ~ 399
●	●	○	●	○	◇	70 ~	20 ~	100 ~	400 ~ 419
○	●	○	●	○	◇	75 ~	21 ~	105 ~	420 ~ 439
●	○	○	●	○	◇	80 ~	22 ~	110 ~	440 ~ 459
○	○	○	●	○	◇	85 ~	23 ~	115 ~	460 ~ 479
●	●	●	○	○	◇	90 ~	24 ~	120 ~	480 ~ 499
○	●	●	○	○	◇	95 ~	25 ~	125 ~	500
●	○	●	○	○	◇	100 ~	26 ~	130 ~	—
○	○	●	○	○	◇	105 ~	27 ~	135 ~	—
●	●	○	○	○	◇	110 ~	28 ~	140 ~	—
○	●	○	○	○	◇	115 ~	29 ~	145 ~	—
●	○	○	○	○	◇	120 ~	30 ~	150 ~	—
○	○	○	○	○	◇	Sensor trouble	31 or more	155 or more	—

○: Go ON ●: Go OFF ◇: flashing (1 time/sec.)

(1)-4. Refrigerant leak detection function

Monitors the amount of refrigerant being circulated based on the temperature sensors, compressor rotation speed, PMV opening during operation, and detects any refrigerant leaks during operation and indicates it using the LEDs on the outdoor unit.

⚠ CAUTION

- * Detects any slow leaks at the stages of not cool not heat and trouble stoppages' during operation but may not detect fast leaks sometimes.
- * Refrigerant leaks may even be detected because of refrigerant circulation failures due to PMV (Pulse Motor Valve) blockages, operation failures, capillary blockages, strainer blockages, etc.
- * Refrigerant leak detection may not be possible depending on the external air temperature conditions during operation.

If any refrigerant leaks are detected ensure to identify where the leak is, recover the remaining refrigerant, and then recharge with the correct amount using the appropriate methods.

[Confirmation method]

- 1) Ensure the LED display shows the initial state. If not then it can be returned to the initial state by pushing and holding down SW01 and SW02 at the same time for at least 5 seconds.
- 2) Push SW01 several times until reaching the 'refrigerant leak indication' LED display.

D800	D801	D802	D803	D804	D805	Refrigerant leak indication Displays if a certain amount of refrigerant has leaked.
●	●	●	○	●	◎	

○ : Go ON ● : Go OFF ◎ : Flash (5 times/sec.)

- 3) Briefly pushing SW02 enables the presence of a leak to be detected using the LED display.

D800	D801	D802	D803	D804	D805	Judgment
●	●	●	●	●	◇	No refrigeration leak detected
○	●	●	●	●	◇	Refrigeration leak detected

○ : Go ON ● : Go OFF ◇ : Flash (1 time/sec.)

- 4) Before exiting, push and hold down SW01 and SW02 at the same time for at least 5 seconds and set the LED to the initial state.

(2) Maintenance inspections Special operations (SW01 and SW02 operations)

The following special maintenance and inspection operations can be carried out using the service switches SW01 and SW02.

[Method of operation]

- 1) Ensure the LED display shows the initial state. If not then please ensure to return it to the initial state.
- 2) Push and hold down SW01 for at least 5 seconds. D804 will start slowly flashing.
- 3) Push SW01 until reaching the LED display function you wish to set.

Special operations	LED display					Control content
Refrigerant recovery operation	D800 ○	D801 ●	D802 ●	D803 ●	D804 ◎	The outdoor unit performs cooling operations. Indoor units do not operate with just this operation and hence do any fan only operations in advance. Refer to 1. (P87)
PMV fully open operation	D800 ○	D801 ●	D802 ○	D803 ●	D804 ◎	PMV (Pulse Motor Valve) fully opens. Perform step 6) below or returns to normal control after 2 minutes. (⇒ Note 1)
PMV fully closed operation	D800 ●	D801 ○	D802 ○	D803 ●	D804 ◎	PMV (Pulse Motor Valve) fully closed. Perform step 6) below or returns to normal control after 2 minutes. (⇒ Note 1)
PMV intermediate open operation	D800 ○	D801 ○	D802 ○	D803 ●	D804 ◎	Sets the PMV (Pulse Motor Valve) to intermediate open (500 pulses). Perform step 6) below or returns to normal control after 2 minutes. (⇒ Note 1)
Indoor heating test command	D800 ○	D801 ●	D802 ●	D803 ○	D804 ◎	Performs a heating test run. Carrying out step 6) below returns to normal control. (⇒ Note 2)
Indoor cooling test run command	D800 ●	D801 ○	D802 ●	D803 ○	D804 ◎	Performs a cooling test run. Carrying out step 6) below returns to normal control. (⇒ Note 2)
Forced fan motor operation	D800 ○	D801 ○	D802 ●	D803 ○	D804 ◎	Forcibly operates the fan motor. Perform step 6) below or returns to normal control after 2 minutes. (⇒ Note 1)
4-way valve relay operation	D800 ●	D801 ●	D802 ○	D803 ○	D804 ◎	Turns on the 4-way valve relay. Perform step 6) below or returns to normal control after 2 minutes. (⇒ Note 1)

○ : Go ON ● : Go OFF ◎ : Flash (5 times/sec.)

Note 1: The operations can take place while the equipment is on but it is better if it has been turned off first. A sudden change in pressure could occur while the operations are taking place, which can be dangerous.

Note 2: Trial indoor cooling operation request / trial indoor heating operation request.

Cooling / Heating test operations can only take place from the outdoor unit when combined with the following indoor units ensure to utilize the outdoor unit.
 Test runs supported : 5 series or later indoor units.
 Not supported : Indoor units other than above. In addition, any when twin connections include any other indoor units than above.

Caution) Forced test operations using this setting cannot be cancelled using the indoor remote control. Refer to 6) below.

- 4) Push SW02 until D805 starts rapidly flashing.
- 5) Push and hold down SW02 for at least 5 seconds. D804 will start slowly flashing and D805 will turn on and the special operation will take effect.
- 6) To invalidate any of the various settings push and hold down SW01 and SW02 at the same time for at least 5 seconds. D800 to D804 will be off (or rapidly flashing) and D805 lit up (initial state: current trouble indication) and the special operation will have been disabled (normal control).
 *If any uncertainty arises then push and hold down SW01 and SW02 at the same time for at least 5 seconds. You will return to step 1).

3. Outdoor application operation

Application Control Kit (TCB-PCOS1E2)

(1) Peak-cut control

- Saves the power of the outdoor unit by the external peak-cut signal to suppress temporary peak power dissipation.
- The power saving can be switched to three levels: 75%, 50%, and operation stop.

(2) Night operation

- Reduces the capacity of the air conditioner by the input signal from a commercially available timer (procured locally) regardless of the outside air temperature or load to reduce operating noise.
- There are some noise levels for Night operation.
By setting DIP switches of Application Control Kit, the noise level in Night operation (Sound reduction) mode can be selected.

1. Make sure of the color (green or black) of the DIP switches (SW01) on the P.C. board.

2. Referring to the table below, set the DIP switches for the desired noise level.

(3) Compressor output

- Turns on the no-voltage contact output while the compressor is operating.

Application Control Kit P.C. board

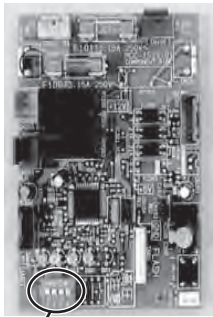

DIP switches (SW01)

SPL: Sound Pressure Level

SW01 selects the noise level in Night operation (Sound reduction) mode.

Noise level	Outdoor operation noise SPL (dB(A))	SW01 setting (switch color: green)	SW01 setting (switch color: black)
level 1	40 dB	<p>OPEN</p>	<p>ON</p>
level 2	45 dB	<p>OPEN</p>	<p>ON</p>

*Don't do any switch settings except above.
It would be the cause of the malfunction.

10 ADDRESS SETUP

10-1. Address Setup Procedure

When an outdoor unit and an indoor unit are connected, or when an outdoor unit is connected to each indoor unit respectively in the group operation even if multiple refrigerant lines are provided, the automatic address setup completes with power-ON of the outdoor unit. The operation of the remote controller is not accepted while automatic address works. (Approx. 4 to 5 minutes)

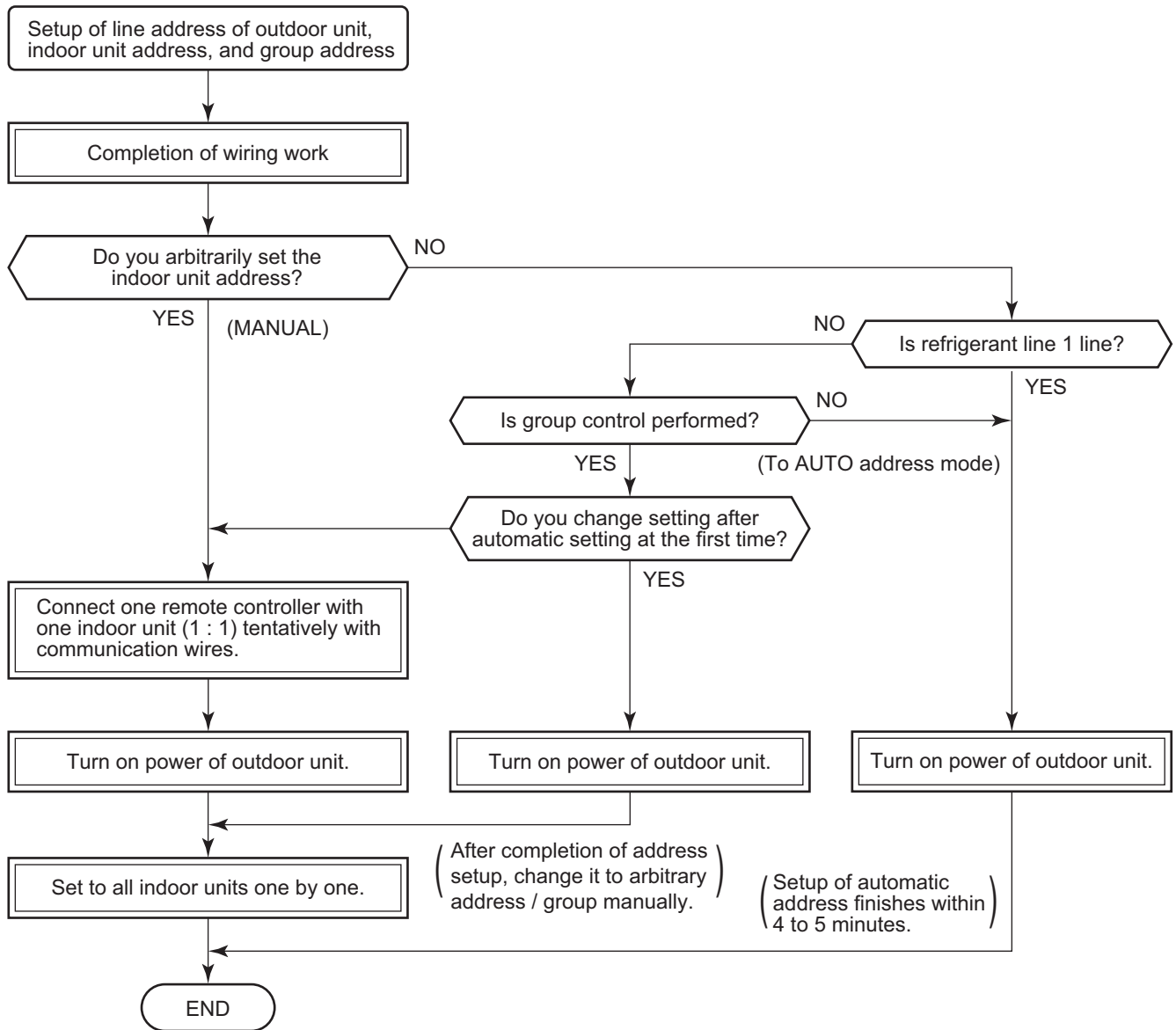

When the following addresses are not stored in the EEPROM on the indoor P.C. board, a test run operation cannot be performed. (Unfixed data at shipment from factory)

	CODE No.	Data at shipment	Setup data range
Line address	12	0099	0001 (No. 1 unit) to 0064 (No. 64 unit)
Indoor unit address	13	0099	0001 (No. 1 unit) to 0064 (No. 64 unit) Max. value of indoor units in the identical refrigerant line
Group address	14	0099	0000: Individual (Indoor units which are not controlled in a group) 0001: Master unit (1 indoor unit in group control) 0002: Sub unit (Indoor units other than master unit in group control)

10-2. Address Setup & Group Control

<Definitions of terms>

- Indoor unit No. : N - n = Outdoor unit line address N (Max. 30) - Indoor unit address n (Max. 64)
- Group address : 0 = Single (Not group control)
1 = Master unit in group control
2 = Sub unit in group control
- Master unit (= 1) : The representative of multiple indoor units in group operation sends / receives signals to / from the remote controllers and sub indoor units.
(* It has no relation with an indoor unit which communicates serially with the outdoor units.)
The operation mode and setup temperature range are displayed on the remote controller LCD.
(Except air direction adjustment of louver)
- Sub unit (= 2) : Indoor units other than master unit in group operation
Basically, sub units do not send / receive signals to / from the remote controllers.
(Except alarm and response to demand of service data)
- Header unit (Representative unit) (Master Twin)
: This unit communicates with the indoor unit (follower) which serial-communicates with the outdoor units and sends / receives signal (Command from compressor) to / from the outdoor units as the representative of the cycle control in the indoor units of the identical line address within the minimum unit which configures one of the refrigerating cycles of Twin.
- Follower unit (Subordinate unit) (Sub Twin)
: Indoor units excluding the header unit in Twin
This unit communicates with (Header) indoor unit in the identical line address and performs control synchronized with (Header) indoor unit.
This unit does not perform the signal send / receive operation with the outdoor units.
No judgment for serial signal trouble.

10-2-1. System Configuration

(1) Single

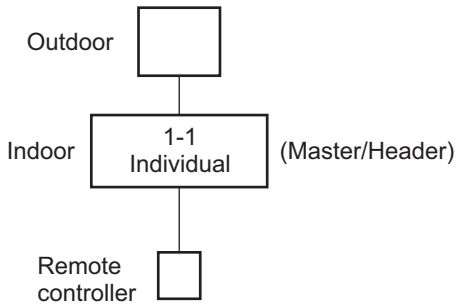

(2) Twin

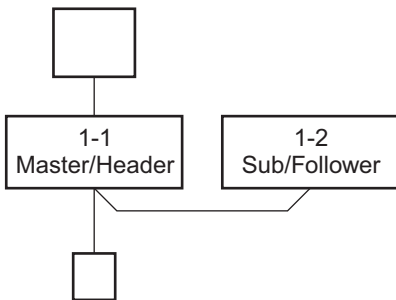

(3) Single group operation

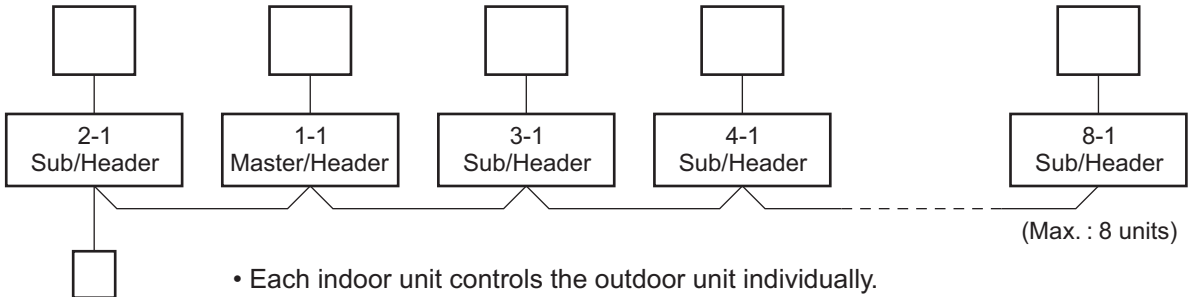

- Each indoor unit controls the outdoor unit individually.

(4) Multiple groups operation (Single, Twin operation)

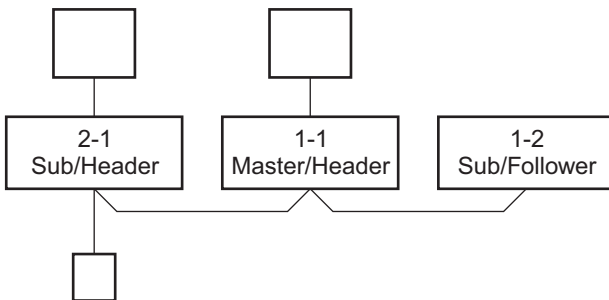

- Header unit : The header unit receives the indoor unit data (thermostat status) of the follower (Without identical line address & indoor / outdoor serial) and then finally controls the outdoor compressor matching with its own thermostat status.
The header unit sends this command information to the follower unit.
- Follower unit : The follower unit receives the indoor unit data from the header (With identical line address & indoor / outdoor serial) and then performs the thermostat operation synchronized with the header unit.
The follower unit sends own thermostat ON/OFF demand to the header unit.
(Example)
No. 1-1 header unit sends / receives signal to / from No. 1-2 follower units.
(It is not influenced by the refrigerating line 1 or 2 address indoor unit.)

10-2-2. Automatic Address Example from Unset Address (No miswiring)

(1) Standard (One outdoor unit)

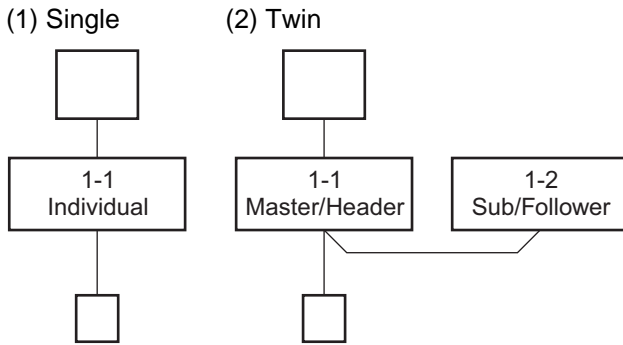

Only turning on source power supply (Automatic completion)

(2) Single group operation

(Multiple outdoor units = Multiple indoor units only with serial communication)

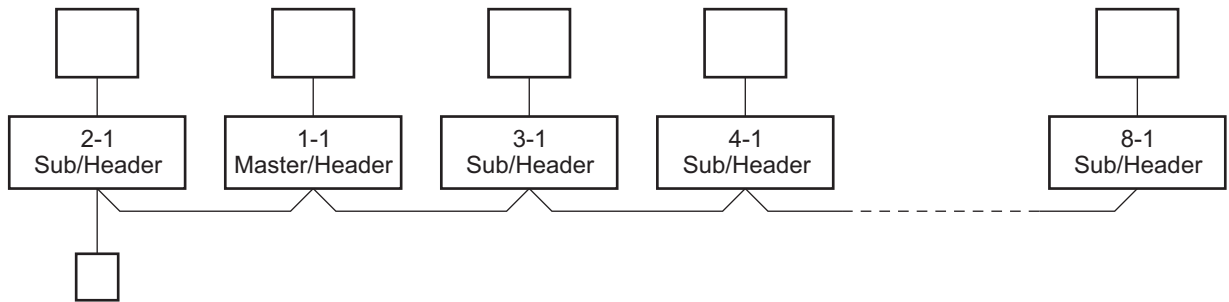

Only turning on source power supply (Automatic completion)

10-3. Remote Controller Wiring

- Strip off approx. 9 mm the wire to be connected.
- For single system, use non polarity, 2 core wire is used for wiring of the remote controller. (0.5 mm² to 2.0 mm² wires)
- For the synchronous twin system, use 2-core shield wire (Vinyl cord for microphone 0.5 to 2.0 mm²) to conform to the EMC standard.

Wiring diagram

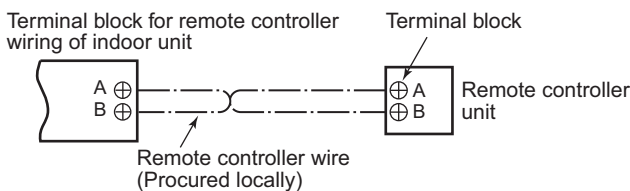

- * For details of wiring / installation of the remote controller, refer to the Installation Manual enclosed with the remote controller.

Simultaneous twin system

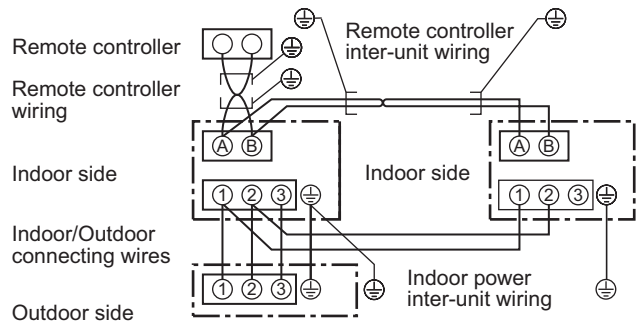

- * Use 2-core shield wire (MVVS 0.5 to 2.0 mm² or more) for the remote controller wiring in the simultaneous twin simultaneous triple and simultaneous double twin systems to prevent noise problems. Be sure to connect both ends of the shield wire to earth leads.
- * Connect earth wires for each indoor unit in the simultaneous twin simultaneous triple and simultaneous double twin system.

10-4. Address Setup (Manual setting from remote controller)

In case that addresses of the indoor units will be determined prior to piping work after wiring work

- Set an indoor unit per a remote controller.
- Turn on power supply.

1 Push **SET** + **CL** + **TEST** buttons simultaneously for 4 seconds or more.

2 (← Line address)
Using the temperature setup **▼** / **▲** buttons, set **1** to the CODE No.

3 Using timer time **▼** / **▲** buttons, set the line address.

4 Push **SET** button.
(OK when display goes on.)

5 (← Indoor unit address)
Using the temperature setup **▼** / **▲** buttons, set **2** to the CODE No.

6 Using timer time **▼** / **▲** buttons, set 1 to the line address.

7 Push **SET** button.
(OK when display goes on.)

8 (← Group address)
Using the temperature setup **▼** / **▲** buttons, set **1** to the CODE No.

9 Using timer time **▼** / **▲** buttons, set **0000** to Individual, **000 1** to Header unit, and **0002** to Follower unit.

10 Push **SET** button.
(OK when display goes on.)

11 Push **TEST** button.
Setup completes. (The status returns to the usual stop status.)

(Example of 2-lines wiring)
(Solid line: Wiring, Broken line: Refrigerant pipe)

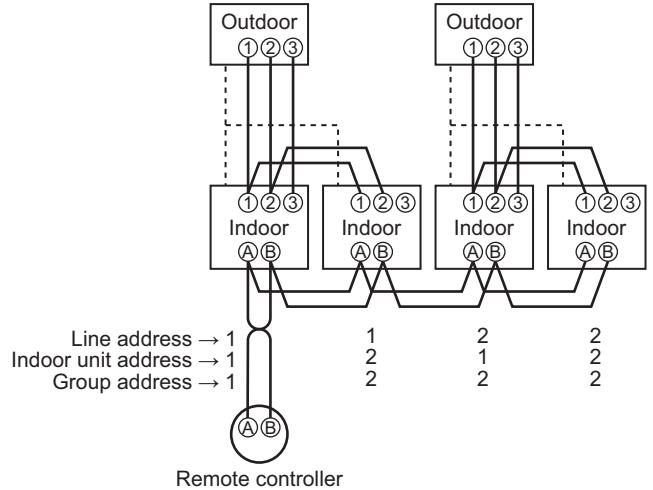

Remote controller

For the above example, perform setting by connecting singly the wired remote controller without remote controller group wiring.

Group address
Individual : 0000
Master unit : 0001
Sub unit : 0002 } In case of group control

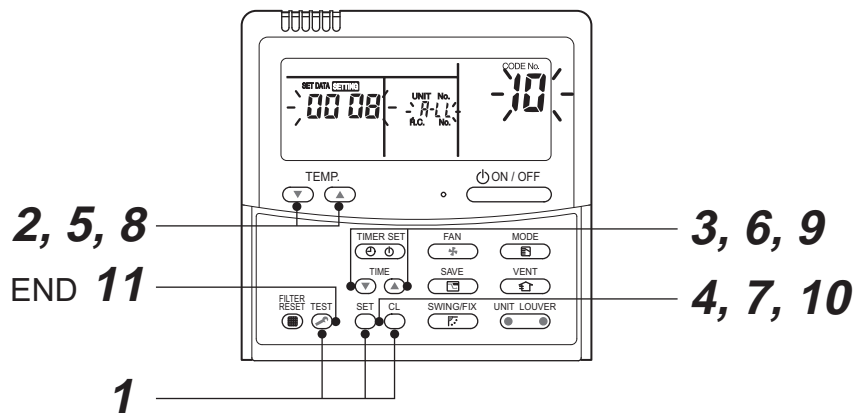

<Operation procedure>



1 → 2 → 3 → 4 → 5 → 6 → 7 → 8 → 9 → 10 → 11 END

10-5. Confirmation of Indoor Unit No. Position

(1) To know the indoor unit addresses though position of the indoor unit body is recognized

In case of individual operation (Wired remote controller : indoor unit = 1 : 1)
 (Follow to the procedure during operation)

<Procedure>

- 1 Push  button if the unit stops.
- 2 Push  button (button of left side).
 Unit No. { - { is displayed on LCD.
 (It disappears after several seconds.)
 The displayed unit No. indicate line address and indoor unit address.
 (When other indoor units are connected to the identical remote controller (Group control unit), other unit numbers are also displayed every pushing  button (button of left side).

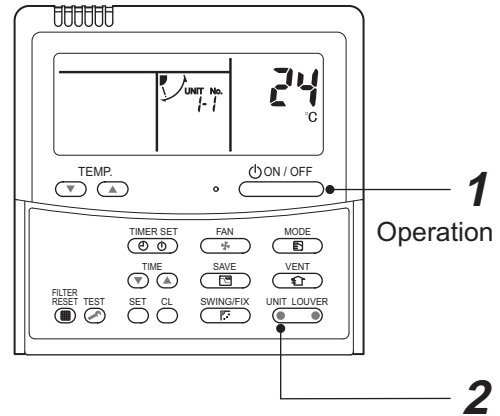

<Operation procedure>





1 → 2 END

(2) To know the position of indoor unit body by address

To confirm the unit No. in the group control
 (Follow to the procedure during operation) (in this procedure, the indoor units in group control stop.)

<Procedure>

The indoor unit numbers in the group control are successively displayed, and fan, louver, and drain pump of the corresponding indoor unit are turned on.
 (Follow to the procedure during operation)

- 1 Push  and  buttons simultaneously for 4 seconds or more.
 - Unit No. ALL is displayed.
 - Fans and louvers of all the indoor units in the group control operate.
- 2 Every pushing  button (button of left side), the unit numbers in the group control are successively displayed.
 - The unit No. displayed at the first time indicates the master unit address.
 - Fan and louver of the selected indoor unit only operate.
- 3 Push  button to finish the procedure.
 All the indoor units in the group control stop.

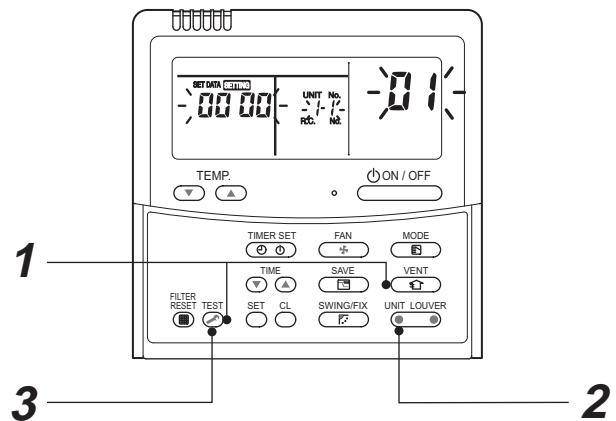

<Operation procedure>

1 → 2 → 3 END

<Maintenance / Check list>

Aiming in environmental preservation, it is strictly recommended to clean and maintain the indoor / outdoor units of the operating air conditioning system regularly to secure effective operation of the air conditioner.

It is also recommended to maintain the units once a year regularly when operating the air conditioner for a long time.

Check periodically signs of rust or scratches, etc. on coating of the outdoor units.

Repair the trouble position or apply the rust resisting paint if necessary.

If an indoor unit operates for approx. 8 hours or more per day, usually it is necessary to clean the indoor / outdoor units once three months at least.

These cleaning and maintenance should be carried out by a qualified dealer.

Although the customer has to pay the charge for the maintenance, the life of the unit can be prolonged.

Failure to clean the indoor / outdoor units regularly will cause shortage of capacity, freezing, water leakage or trouble on the compressor.

Part name	Object		Contents of check	Contents of maintenance
	Indoor	Outdoor		
Heat exchanger	✓	✓	• Blocking with dust, damage check	• Clean it when blocking is found.
Fan motor	✓	✓	• Audibility for sound	• When abnormal sound is heard
Filter	✓	—	• Visual check for dirt and breakage	• Clean with water if dirty • Replace if any breakage
Fan	✓	✓	• Visual check for swing and balance • Check adhesion of dust and external appearance.	• Replace fan when swinging or balance is remarkably poor. • If a large dust adheres, clean it with brush or water.
Suction / Discharge grille	✓	—	• Visual check for dirt and scratch	• Repair or replace it if deformation or damage is found.
Drain pan	✓	—	• Check blocking by dust and dirt of drain water.	• Clean drain pan, Inclination check
Front panel, Louver	✓	—	• Check dirt and scratch.	• Cleaning / Coating with repair painting
External appearance	—	✓	• Check rust and peeling of insulator • Check peeling and floating of coating film	• Coating with repair painting

11 REPLACEMENT OF THE SERVICE P.C. BOARD

⚠ WARNING

Don't open the inverter cover before 1 minute after power has been turned off because an electric shock may be occurred.

RAV-GP561ATW*

Replacement steps:

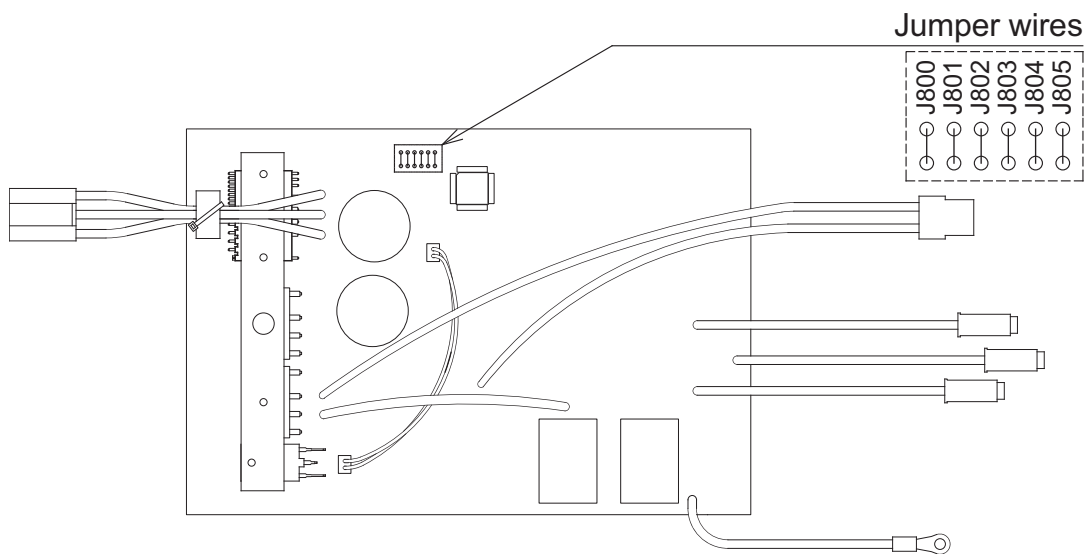

(1) Jumper wires "J800 ~ J803"

Cut the jumper wires of the service board, as instructed in the table below.

The jumper setting of J800 ~ J803 differs from original supplied P.C. board, therefore be sure to configure the jumpers as in the table below. If the model is specified, the equipment will not operate.

Model name	J800	J801	J802	J803
Service P.C. board	O	O	O	O
RAV-GP561ATW*	X	O	O	O

O: Connected, X: Cut

*: Characters indicate the country code (-E), (-TR), and etc.
(Example: RAV-GP561ATW-E)

(2) Jumper wires "J804 ~ J805"

Set the jumper wires J804 ~ J805 of the service board to the same as settings of the P.C. board before replacement.

RAV-GP801ATW*

(1) DN setting the jumper wires and DIP switches

Part name	Function	Setting
Jumper wire J800 ~ J804	Model switching	Cut these jumper wires according to the following table.
J805 ~ J807	Settings	Set these jumper wires same as the settings of the P.C. board before replacement.

Model switching (J800 to J804)

Since this service P.C. board is available for several models, cut the jumper wires according to the following table. If they are not cut correctly, a check code "L10" or "L29" appears on the remote controller and the operation of the air conditioner is disabled.

Model name	J800	J801	J802	J803	J804
Factory setting (default)	O	O	O	O	O
RAV-GP801ATW*	X	O	O	O	O

O: Connected, X: Cut

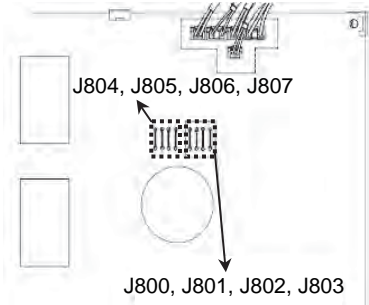

*: Characters indicate the country code (-E), (-TR), and etc.
(Example: RAV-GP801ATW-E)

(2) Installing the P.C. board

- Please remove below parts in the following order.
① screw A (4p), ② COVER, ③ screw B (3p), ④ HEATSINK
- Please remove the following parts from the P.C. board, and attach them to a Service P.C. board.
⑤ ZCAT2132-1130 (1p), ⑥ ZCAT2032-0930 (2p), ⑦ TUBE, ⑧ FUSE-COVER, ⑨ SPACER
- Apply thermal grease to SUB-HEATSINK of Service P.C. board.
- After installing Service P.C. board and HEATSINK, Attach the removed parts and tighten by screws.
- Connect the lead wires according to the wiring diagram stuck on the backside of the panel.
- About the model of No. 01, Insert the connector of fan motor into CN300. (Don't use CN400).
About the model of No. 02 - 03, insert the connector of the upper fan motor into CN400,
Insert the connector of the lower fan motor into CN300.

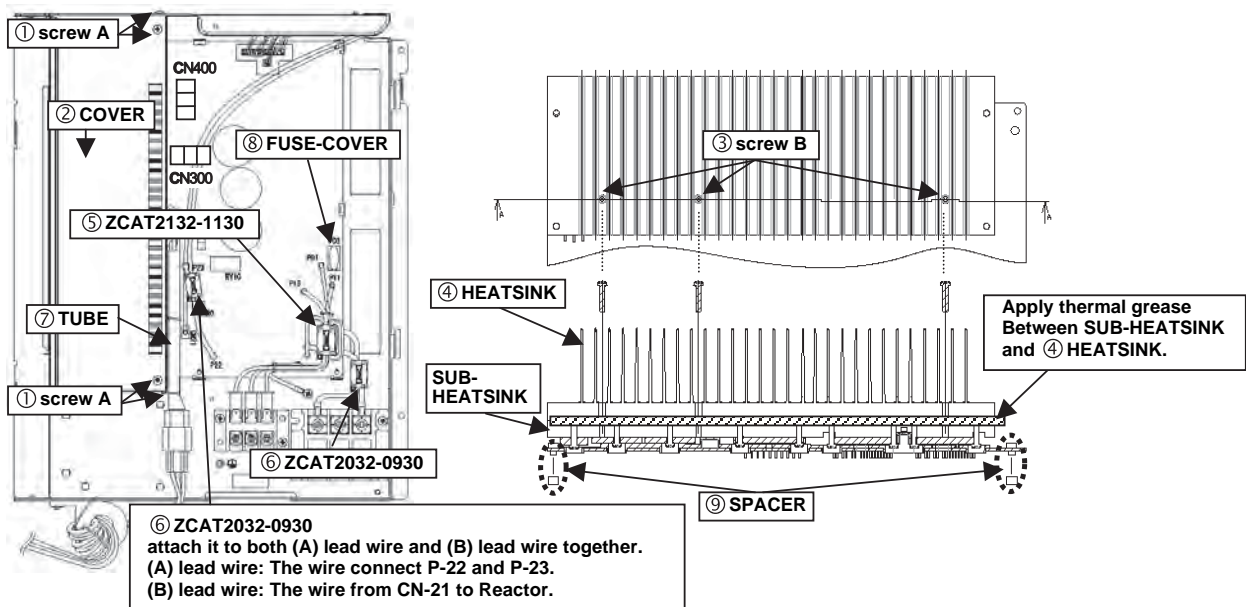

12 HOW TO EXCHANGE COMPRESSOR

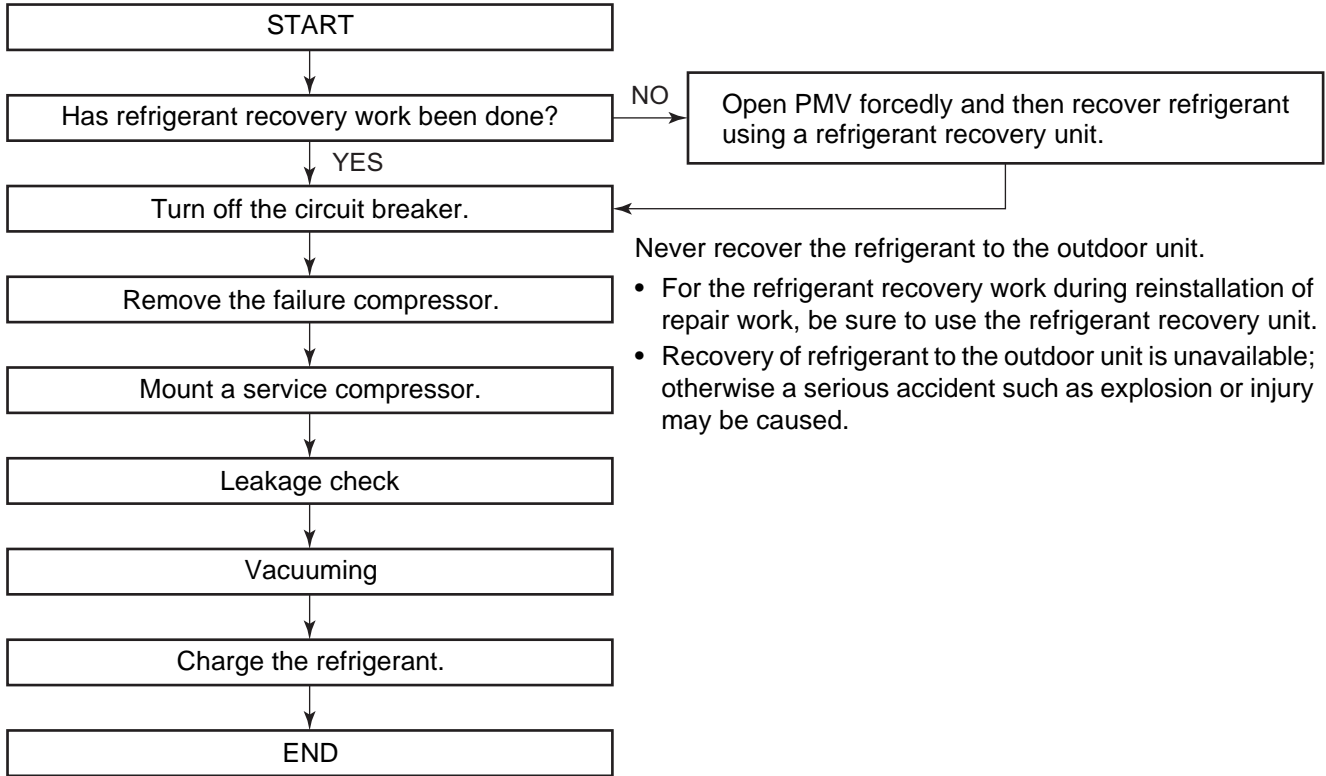

12-1. Exchanging Procedure of Compressor (Outline)





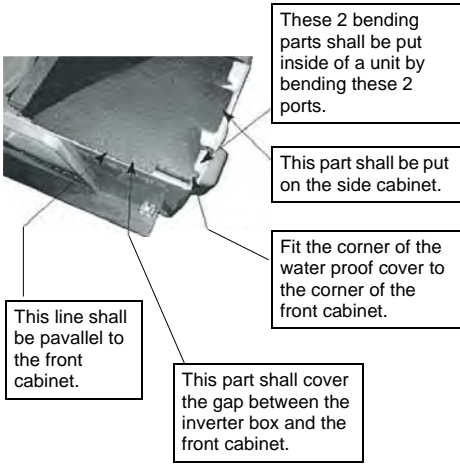

For exchange of compressors, refer to (7) Compressor in Section 13 DETACHMENTS.

13 DETACHMENTS



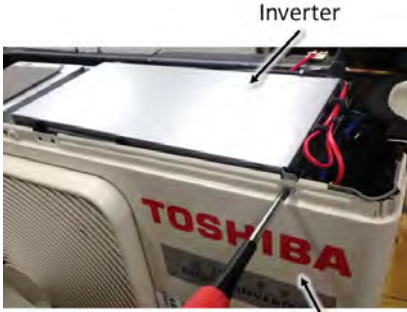
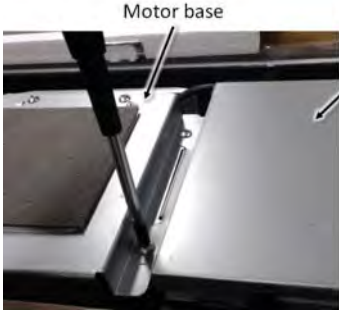

13-1.RAV-GP561ATW*

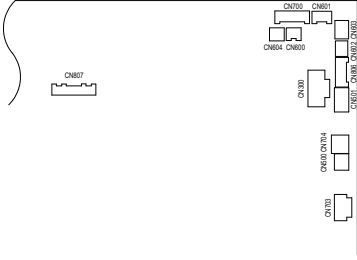
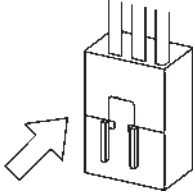
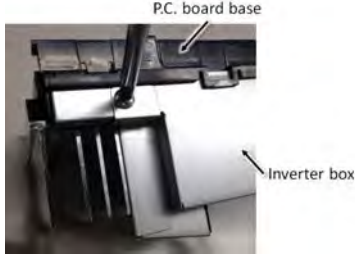
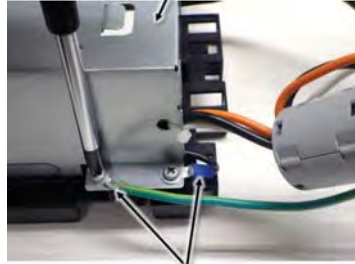

No.	Part name	Procedure	Remarks
(1)	Common procedure	<p>⚠ WARNING</p> <hr/> <p>Stop operation of the air conditioner and turn off breaker switch.</p> <hr/> <p>⚠ CAUTION</p> <hr/> <p>Ensure wearing of gloves when performing any work in order to avoid injury from parts, etc.</p> <hr/> <p>1. Detachment</p> <ol style="list-style-type: none"> 1) Stop operation of the air conditioner, and turn off the main switch of the breaker for air conditioner. 2) Remove the valve cover. (3 pcs, M4 × 10 hexagon screws) <ul style="list-style-type: none"> • After removing screw, remove the valve cover pulling it downward. 3) Remove the wiring cover. (1 pc, M4 × 8 truss screw) <ul style="list-style-type: none"> • After removing screw, remove the wiring cover pulling it upward. 4) Remove cord clamp (3 pcs, M4 × 14 truss screws), and then remove connecting cable. 5) Remove the upper cabinet. (5 pcs, M4 × 10 hexagon screws) <ul style="list-style-type: none"> • After removing screws, remove the upper cabinet pulling it upward. 6) Remove the water-proof cover. <p>2. Attachment</p> <ol style="list-style-type: none"> 1) Attach the water-proof cover. <p>NOTE</p> <p>The water-proof cover must be attached without fail in order to prevent rain water, etc. from entering inside the indoor unit.</p> <hr/> <ol style="list-style-type: none"> 2) Attach the upper cabinet. (5 pcs, M4 × 10 hexagon screws) 3) Perform cabling of connecting wires, and attach the cord clamp. <ul style="list-style-type: none"> • Fix the cord clamp by tightening the screws (3 pcs, M4 × 14 truss screws), fitting 2 concave parts of the cord clamp to each connecting wires. 4) Attach the wiring cover. (1 pc, M4 × 8 truss screw) 5) Attach the valve cover. (3 pcs, M4 × 10 hexagon screws) <ul style="list-style-type: none"> • Insert the upper part into the square hole of the side cabinet, set hook claws of the valve cover to square holes (at three positions) of the main unit, and attach it pushing upward. 	 <p>Valve cover</p>  <p>Wiring cover Cord clamp</p>  <p>Upper cabinet Front cabinet Water-proof cover</p>  <p>These 2 bending parts shall be put inside of a unit by bending these 2 parts.</p> <p>This part shall be put on the side cabinet.</p> <p>Fit the corner of the water proof cover to the corner of the front cabinet.</p> <p>This part shall cover the gap between the inverter box and the front cabinet.</p> <p>This line shall be parallel to the front cabinet.</p> <p>How to mount the water-proof cover</p>

No.	Part name	Procedure	Remarks
(2)	Front cabinet	<p>1. Detachment</p> <ol style="list-style-type: none"> 1) Following to work of Detachment of (1). 2) Remove the fixing screw (1 pc, M4 × 8 truss screw) used to secure the front cabinet and inverter cover, the screws (4 pcs, M4 × 10 hexagon screws) used to secure the front cabinet at the bottom, and the fixing screws (2 pcs, M4 × 8 truss screws) used to secure the motor base. <ul style="list-style-type: none"> • The front cabinet is fitted into the side cabinet (left) at the front left side so pull up the top of the front cabinet to remove it. <p>2. Attachment</p> <ol style="list-style-type: none"> 1) Insert the claw on the front left side into the side cabinet (left). 2) Hook the bottom part of the front right side onto the concave section of the bottom plate. Insert the claw of the side cabinet (right) into the square hole in the front cabinet. 3) Return the screws that were removed above to their original positions and attach them. 	 <p>The top photograph shows the front cabinet being detached from the side cabinet. An arrow labeled 'Corner hole' points to the bottom-left corner of the front cabinet, and another arrow labeled 'Hook' points to the top-right corner of the side cabinet. The bottom photograph shows the front cabinet being attached to the side cabinet. An arrow labeled 'Corner hole' points to the bottom-left corner of the front cabinet, and another arrow labeled 'Hook' points to the top-right corner of the side cabinet.</p>

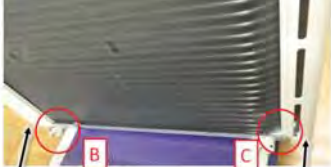
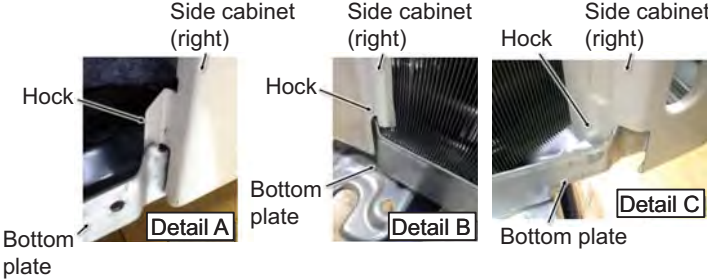

No.	Part name	Procedure	Remarks
(3)	Inverter assembly	<p>1. Detachment</p> <p>1) Following to work of Detachment of (1).</p> <p>2) Remove screw (1 pc, M4 × 8 truss screw) of the upper part of the front cabinet.</p> <ul style="list-style-type: none"> • If removing the inverter cover in this condition, P.C. board can be checked. • If there is no space above the unit, perform work of 1 in (2). <p>⚠ CAUTION</p> <p>Be careful to check the inverter because high-voltage circuit is incorporated in it.</p> <hr/> <p>3) Perform discharging by connecting (+), (-) polarity by discharging resistance (approx. 100 Ω, 40 W) or plug of soldering iron to (+), (-) terminals a of the C10 (printed "WARNING HIGH VOLTAGE" is attached.) electrolytic capacitor (500 μF) on P.C. board.</p> <p>⚠ CAUTION</p> <p>Be careful to discharge the capacitor because the electrolytic capacitor cannot naturally discharge and voltage remains according to trouble type in some cases.</p> <hr/> <p>NOTE</p> <p>This capacitor is one with mass capacity. Therefore, it is dangerous that a large spark generates if short-circuiting between (+), (-).</p> <p>4) Remove screws (4 pcs, M4 × 8 truss screws) fixing the terminal part of inverter box to the side cabinet (right).</p> <p>5) Remove the front cabinet by performing step 1 in (2), and remove the fixing screw (1 pc, M4 × 8 truss screw) for securing the partition plate and inverter box.</p> <p>6) Remove the fixing screw (1 pc, M4 × 8 truss screw) securing the wiring cover and inverter box.</p> <ul style="list-style-type: none"> • After removing screw, remove the wiring cover pulling it downward. <p>7) Remove the fixing screws (2 pcs, M4 × 8 truss screws) for securing the motor base and inverter box.</p> <p>8) Remove various lead wires from the holder at upper part of the inverter box.</p> <p>9) Pull the inverter box upward.</p> <p>10) Disconnect connectors of various lead wires. (Refer to next page for detail of lead wires and connector)</p> <p>REQUIREMENT</p> <p>As each connector has a lock mechanism, avoid to remove the connector by holding the lead wire, but by holding the connector.</p>	 <p>Inverter</p> <p>Front cabinet</p>  <p>Motor base</p> <p>Inverter</p>  <p>Inverter cover</p>  <p>Plug of soldering iron</p> <p>Discharging position (Discharging period 10 seconds or more)</p>  <p>The connector is one with lock, so remove it while pushing the part indicated by an arrow.</p> <p>Be sure to remove the connector by holding the connector, not by pulling the lead wire.</p>

No.	Part name	Procedure	Remarks
(3)	Inverter assembly (Continued)	<p>Disconnect the lead wires and connectors connected to the other parts from the P.C. board assembly.</p> <p>1) Lead wires</p> <ul style="list-style-type: none"> • Lead wires connected to compressor: Disconnect the connector (3P). • Lead wires connected to reactor: Disconnect the two connectors (2P). <p>2) Connectors</p> <p>CN300: Outdoor fan motor (3P: white) CN600: TE sensor (2P: white) CN700: PMV (6P: white) CN603: TS sensor (3P: white) CN601: TD sensor (3P: white) CN602: TO sensor (2P: yellow) CN704: 4-way valve (2P: white) CN604: TL sensor (2P: white) CN500: Bimetal thermostat (2P: blue) CN501: High pressure switch (2P: green)</p> <p>NOTE</p> <p>These connectors have a disconnect prevention mechanism: as such, the lock on their housing must be released before they are disconnected.</p>	 <p>Connectors with locking mechanisms: as such, to disconnect them, they must be pressed in the direction of the arrow while pulling them out.</p> 
(4)	P.C. board assembly	<p>1) Remove the screws (2 pcs, M4 × 8 truss screws) fixing inverter box and P.C. board base.</p> <p>2) Remove the earth screw fixing inverter box and earth lead.</p> <p>3) Remove the P.C. board assembly from the P.C. board base. (Remove the heat sink and P.C. board assembly while keeping them screwed together.)</p> <p>NOTE</p> <p>Disengage the four claws of the P.C. board base, hold the heat sink, and lift to remove it.</p> <p>4) Remove the two fixing screws used to secure the heat sink and P.C. board assembly.</p> <p>NOTE</p> <p>When mounting the new P.C. board assembly, ensure that the P.C. board is inserted properly into the P.C. board base support groove.</p>	 <p>P.C. board base Inverter box</p>  <p>Inverter box Earth lead wires</p>



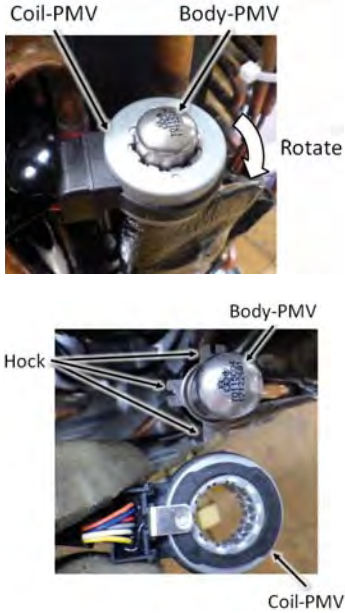
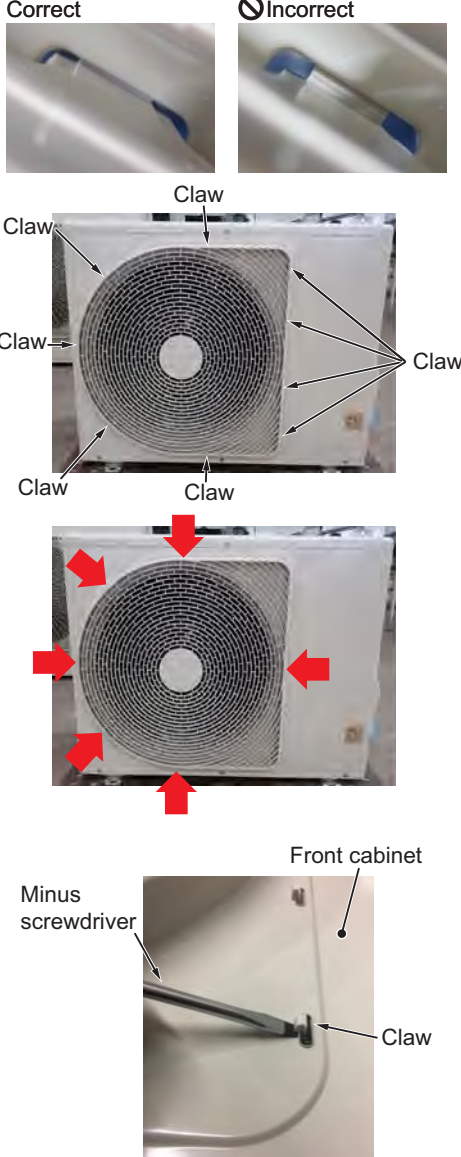

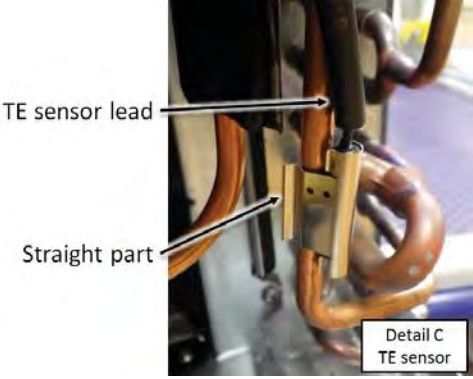
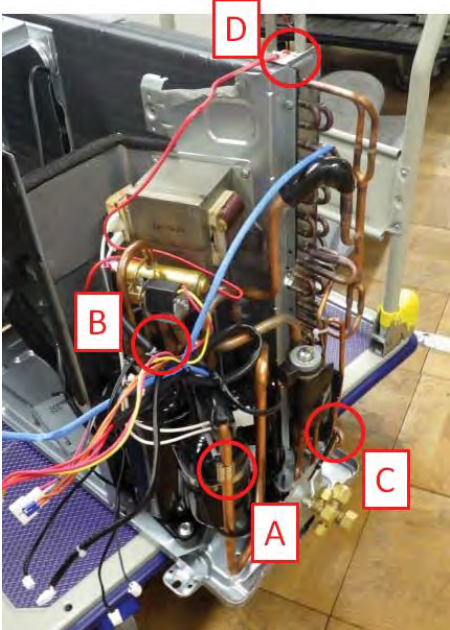
No.	Part name	Procedure	Remarks
(5)	Side cabinet	<p>1. Side cabinet (right)</p> <ol style="list-style-type: none"> Following to work of Detachment of (2) and (3). Remove the fixing screws (3 pcs, M4 × 8 truss screws) used for securing the side cabinet (right) to the bottom plate and valve fixing plate. <p>2. Side cabinet (left)</p> <ol style="list-style-type: none"> Following to work of Detachment of (2). Remove the fixing screw (1 pc, M4 × 10 hexagon screw) used for securing the side cabinet to the bottom plate. Remove the fixing screws (2 pcs, M4 × 8 truss screws) used for securing the side cabinet to the heat exchanger. 	 <p>Side cabinet (right)</p> <p>Valve fixing plate</p> <p>Bottom plate</p>  <p>Side cabinet (left)</p> <p>Bottom plate</p>  <p>Side cabinet (right)</p> <p>Side cabinet (left)</p>  <p>Side cabinet (right)</p> <p>Hock</p> <p>Bottom plate</p> <p>Detail A</p> <p>Side cabinet (right)</p> <p>Hock</p> <p>Bottom plate</p> <p>Detail B</p> <p>Side cabinet (right)</p> <p>Hock</p> <p>Bottom plate</p> <p>Detail C</p>
(6)	Fan motor	<ol style="list-style-type: none"> Following to work of Detachment of (2) and (3). Remove the flange nut fixing the fan motor and the propeller. <ul style="list-style-type: none"> Flange nut is loosened by turning clockwise. (To tighten the flange nut, turn counterclockwise.) Remove the propeller fan. Disconnect the connector for fan motor from the inverter. Remove the fixing screws (4 pcs, M4 × 8 truss screws) holding by hands so that the fan motor does not fall. <ul style="list-style-type: none"> Precautions when assembling the fan motor. Tighten the flange nut using a tightening torque of 4.9 N•m. 	 <p>Propeller fan</p> <p>Fan motor</p> <p>Bottom plate</p> <p>Motor base</p>

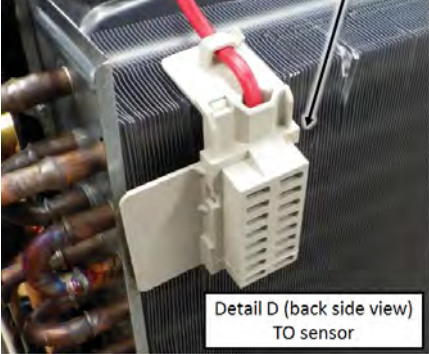

No.	Part name	Procedure	Remarks
(7)	Compressor	<ol style="list-style-type: none"> 1) Following to work of Detachment of (1), (2), (3), (4) and (5). 2) Extract refrigerant gas. 3) Remove the partition plate. (4 pcs, M4 × 8 truss screws) 4) Remove the sound insulation material. 5) Remove terminal cover of the compressor, and disconnect lead wire of the compressor from the terminal. <p>NOTE</p> <p>Never reuse the compressor lead wires which you disconnected. Use the new one. If you reuse it, it may malfunction.</p> <ol style="list-style-type: none"> 6) Remove pipe connected to the compressor with a burner. <ul style="list-style-type: none"> • Take care to keep the 4-way valve away from naked flames. (Otherwise, it may malfunction.) 7) Remove the fixing screw of the bottom plate and heat exchanger. (1 pc, M4 × 8 truss screw) 8) Remove the fixing screws of the bottom plate and valve fixing plate. (2 pcs, M4 × 10 hexagon screws) 9) Pull upward the refrigeration cycle. 10) Remove NUT (3 pcs, H13 nuts) fixing the compressor to the bottom plate. 	 <p>Partition plate</p> <p>Compressor</p> <p>Valve fixing plate</p>
(8)	Reactor	<ol style="list-style-type: none"> 1) Following to work of Detachment of (2) and (3). 2) Remove screws fixing the reactors. (2 pcs, M4 × 8 truss screws) 	 <p>Partition plate</p> <p>Reactor</p>

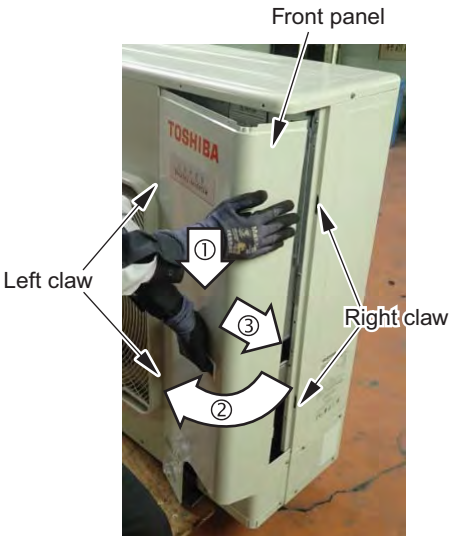

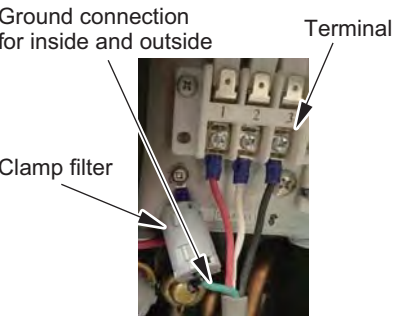
No.	Part name	Procedure	Remarks
(9)	Electronic expansion valve coil	<p>1. Detachment</p> <p>1) Following to work of Detachment of (2), (3) and (5). 2) Remove the coil by pulling it up from the electronic control valve body.</p> <p>2. Attachment</p> <p>1) When assembling the coil into the valve body, ensure that the coil anti-turn lock is installed properly in the pipe.</p> <p><Handling precaution> When handling the parts, do not pull the lead wires. When removing the coil from the valve body, use your hand to secure the body in order to prevent the pipe from being bent out of shape.</p>	
(10)	Fan guard	<p>1. Detachment</p> <p>1) Following to work of Detachment of (2). 2) Remove the front cabinet, and put it down so that fan guard side directs downward.</p> <p>NOTE</p> <p>Perform work on a corrugated cardboard, cloth, etc. to prevent flaw to the product.</p> <p>3) Remove the hooking claws by pushing minus screwdriver according to the arrow mark in the right figure, and remove the fan guard.</p> <p>2. Attachment</p> <p>1) Insert claws of the fan guard in the holes of the front cabinet. Push the hooking claws (9 positions) by hands and fix the claws.</p> <p>NOTE</p> <p>Check that all the hooking claws are fixed to the specified positions. (Push the fan guard in the direction of outside toward center and check that the hooking claws have fallen.)</p>	

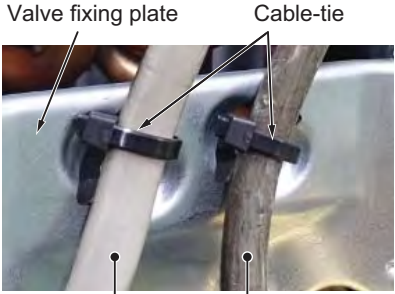
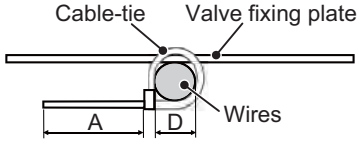

No.	Part name	Procedure	Remarks
(11)	TE sensor (outdoor heat exchanging temperature sensor) • Attachment Install the sensor onto the straight pipe part of the condenser outlet pipe.		
(12)	TS sensor (Suction pipe temperature sensor) • Attachment Install the sensor onto the straight pipe part of the suction pipe. Be careful for the lead wires direction of the sensor.		
(13)	TD sensor (Discharge pipe temperature sensor) • Attachment Install the sensor onto the straight pipe part of the discharge pipe. Be careful for the lead wires direction of the sensor.		
(14)	TO sensor (Outside air temperature sensor) • Attachment Insert the outdoor air temperature sensor into the holder, and install the holder onto the heat exchanger.	 	
<p>⚠ CAUTION</p> <ul style="list-style-type: none"> • During the installation work (and on its completion), take care not to damage the coverings of the sensor leads on the edges of the metal plates or other parts. It is dangerous for these coverings to be damaged since damage may cause electric shocks and/or a fire. • After replacing the parts, check whether the positions where the sensors were installed are the proper positions as instructed. The product will not be controlled properly and trouble will result if the sensors have not been installed in their proper positions. 			



13-2.RAV-GP801ATW*

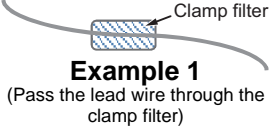
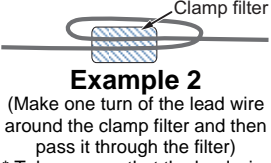
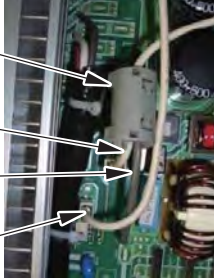

No.	Part name	Procedure	Remarks
(1)	<p>Common procedures</p> <p>Front panel Top cover</p>	<p>⚠ WARNING</p> <hr/> <p>Stop operation of the air conditioner and turn off breaker switch.</p> <hr/> <p>⚠ CAUTION</p> <hr/> <p>Ensure wearing of gloves when performing any work in order to avoid injury from parts, etc.</p> <hr/> <p>1. Detachment</p> <ol style="list-style-type: none"> 1) Stop operation of the air conditioner, and turn off the main switch of the breaker for air conditioner. 2) Remove the front panel. (3 pcs, M4 x 10 hexagon screws) (1) After removing the screws slide the front panel downwards. (2) Pull the front panel forwards and then loosen the right claw. (3) Pull the front panel to the right, loosen the left claw, and then remove the front panel. 3) Remove the terminal cover. (2 pcs, M4 x 8 truss screws) 4) Remove the power and indoor / outdoor connection wires from the cable-ties and terminals. 5) Remove the top cover. (6 pcs, M4 x 10 hexagon screws) 	   

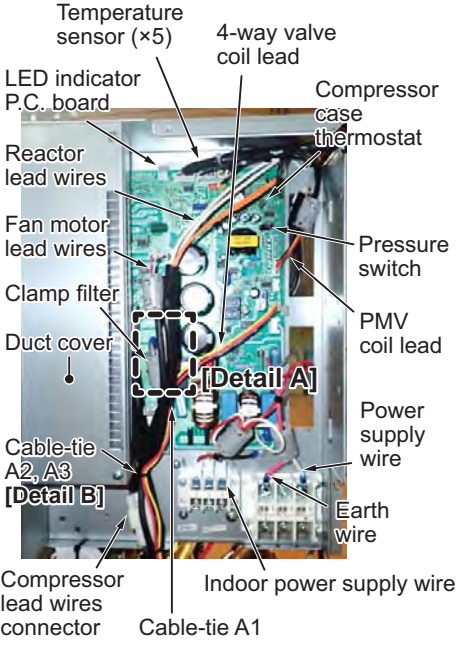
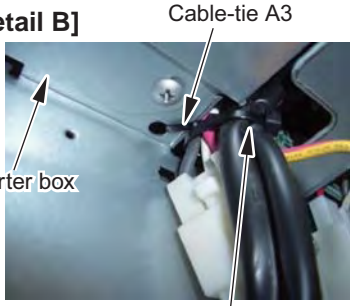
No.	Part name	Procedure	Remarks								
(1)	Common procedures Front panel Top cover (Continued)	<p>2. Attachment</p> <p>1) Attach the top cover. (6 pcs, M4 × 10 hexagon screws)</p> <p>2) Connect the power and indoor / outdoor connection wires to the terminal. * Check that the clamp filter is attached to the ground of the inside-outside connection wiring.</p> <p>3) Fix each wire tightly to the valve fixing plate with the cable-ties. Measure the diameter of the wire to be fixed, and fasten the wire with the supplied cable-ties (T50R-HSW from HellermannTyton) so that length A of the surplus portion of the tie satisfies the following expression: $A = 183 - L$ A: Minimum length of surplus portion of cable-ties (mm) L: Circumferential length of wire (mm) $L = \text{Diameter of wire } D \text{ (mm)} \times \pi$</p> <p>4) Cut off the tie surplus portion (A) of the cable-ties. Cable-ties specifications</p> <table border="1" data-bbox="456 869 959 999"> <thead> <tr> <th>Model</th> <th>Material</th> <th>Flame retardant grade</th> <th>Manufacturer</th> </tr> </thead> <tbody> <tr> <td>T50R-HSW</td> <td>Nylon 66</td> <td>UL94V-2</td> <td>Hellermann Tyton</td> </tr> </tbody> </table> <p>⚠ CAUTION</p> <ul style="list-style-type: none"> An installation fuse must be used for the power supply line of this air conditioner. Incorrect / incomplete wiring may lead to an electrical fire or smoke. Prepare a dedicated power supply for the air conditioner. <p>5) Attach the terminal cover. (2 pcs, M4 × 8 truss screws)</p> <p>6) Attach the front panel. (3 pcs, M4 × 10 hexagon screws)</p>	Model	Material	Flame retardant grade	Manufacturer	T50R-HSW	Nylon 66	UL94V-2	Hellermann Tyton	 <p>Valve fixing plate Cable-tie</p> <p>Indoor / Outdoor connecting wires Power supply wire</p> 
Model	Material	Flame retardant grade	Manufacturer								
T50R-HSW	Nylon 66	UL94V-2	Hellermann Tyton								
(2)	Side cabinet (left)	<p>1. Detachment</p> <p>1) Following to work of Detachment of (1). 2) Remove the stay plate screws while holding the stay plate by hand. (2 pcs, M4 × 10 hexagon screws)</p> <p>2. Attachment</p> <p>Attach the stay plate in the reverse process of "1. Detachment".</p>	 <p>Stay plate</p>								

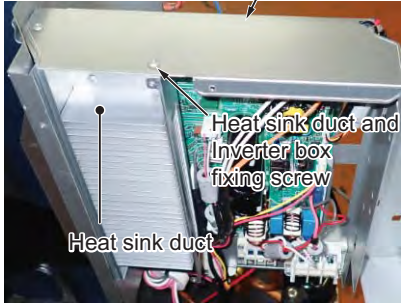
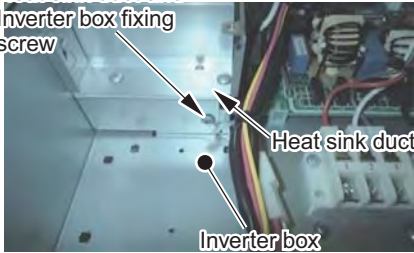
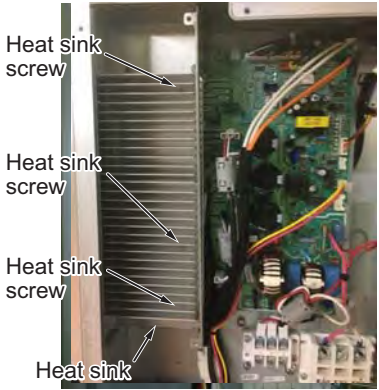

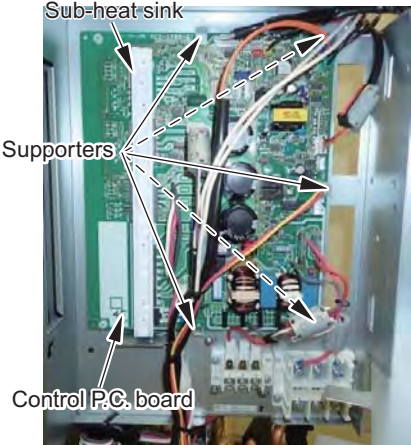
No.	Part name	Procedure	Remarks
(3)	Air-outlet cabinet	<p>1. Detachment</p> <ol style="list-style-type: none"> 1) Following to work of Detachment of (1) and (2). 2) Remove the screws from the Air-outlet cabinet and separate partition. (3 pcs, M4 × 8 truss screws) 3) Remove the screws from the Air-outlet cabinet and base plate. (2 pcs, M4 × 10 hexagon screws) 4) Remove the screws from the Air-outlet cabinet and motor base. (2 pcs, M4 × 8 truss screws) 5) Remove the screws from the Air-outlet cabinet and heat exchanger. (3 pcs, M4 × 8 truss screws) <p>2. Attachment</p> <p>Attach the Air-outlet cabinet in the reverse process of "1. Detachment".</p>	 <p>Heat exchanger Motor base</p> <p>Air-outlet cabinet</p> <p>Base plate Partition plate</p>
(4)	Side cabinet (right)	<p>1. Detachment</p> <ol style="list-style-type: none"> 1) Following to work of Detachment of (3). 2) Remove the screws fixing the inverter assembly and side cabinet (right). (2 pcs, M4 × 8 truss screws) 3) Remove the screws from the side cabinet (right) and valve fixing plate. (2 pcs, M4 × 8 truss screws) 4) Remove the screws from the side cabinet (right) and piping panel (rear). (2 pcs, M4 × 10 hexagon screws) 5) Remove the screw from the side cabinet (right) and base plate. (1 pc, M4 × 10 hexagon screw) 6) Remove the screws from the side cabinet (right) and heat exchanger. (3 pcs, M4 × 10 hexagon screws) <p>2. Attachment</p> <p>Attach the side cabinet (right) in the reverse process of "1. Detachment".</p>	 <p>Heat exchanger Inverter assembly</p> <p>Side cabinet (right)</p> <p>Piping panel (rear)</p> <p>Base plate</p>

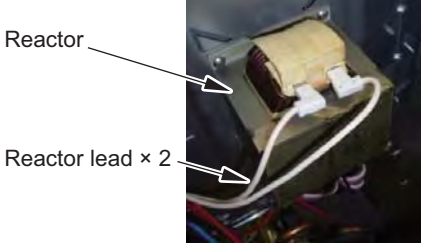
No.	Part name	Procedure	Remarks
(5)	Electrical part (P.C. board)	<p>1. Detachment (P.C. board)</p> <p>1) Following to work of Detachment of (1).</p> <p>⚠ WARNING</p> <p>Do not disassemble the inverter for a minute after the power is turned off since there is a risk of electric shock.</p> <p>*1. Ensure to bundle again with a commercially available cord clamp.</p>  <p>Example 1 (Pass the lead wire through the clamp filter)</p>  <p>Example 2 (Make one turn of the lead wire around the clamp filter and then pass it through the filter) * Take care so that the lead wire does not get tangled.</p> <p>*2. Ensure to fix the clamp filter where it was removed when reassembling the inverter.</p> <p>2) Remove a screw fixing inverter box and inverter cover (Upper side).</p> <p>3) Loosen a screw fixing inverter box and inverter cover (Lower side).</p> <p>4) Cut the cable-tie A1 bundling the fan motor lead wires, compressor case thermostat lead wires, 4-way valve coil lead wires and reactor lead wires. (one position)</p> <p>5) Cut the cable-tie A2 bundling the compressor lead wires, compressor case thermostat lead wires, 4-way valve coil lead wires and fan motor. (one position)</p> <p>6) Remove the clamp filter from the reactor lead wires A1 and P.C. board lead wires.</p>  <p>[Detail A]</p> <p>Clamp filter (Example 1)</p> <p>Reactor lead wires B1</p> <p>P.C. board lead wire</p> <p>Reactor lead wires B2</p> <p>7) Remove the reactor lead wires B1 and the reactor lead wires B2 from control P.C. board.</p> <p>8) Cut the cable-tie A3 fixing compressor lead wires and inverter box.</p> <p>9) Remove the connector connecting to the control P.C. board. (Temperature sensor, PMV coil, 4-way valve coil, Compressor case thermostat, Pressure switch, Fan motor, LED indicator P.C. board)</p> <p>10) Remove the connector of the compressor lead wires. * Release the lock on the housing part to remove the connector.</p> <p>11) Remove the earth wire connecting to the P.C. board. (1 pc, M4 × 8 truss screw)</p> <p>12) Remove supply wire (Red (L), White (N)) or indoor supply wire from each P.C. board</p> <p>13) Remove the duct cover. (2 pcs, M4 × 8 truss screws)</p>	   <p>[Detail B]</p> <p>Cable-tie A3</p> <p>Inverter box</p> <p>Cable-tie A2</p>

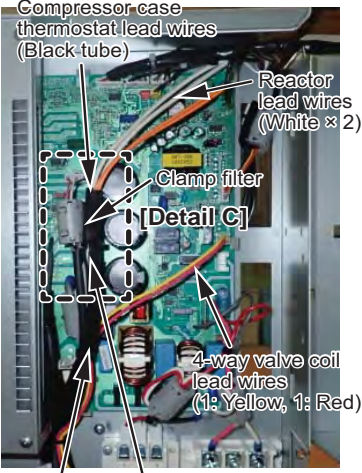
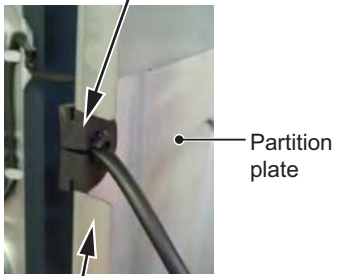

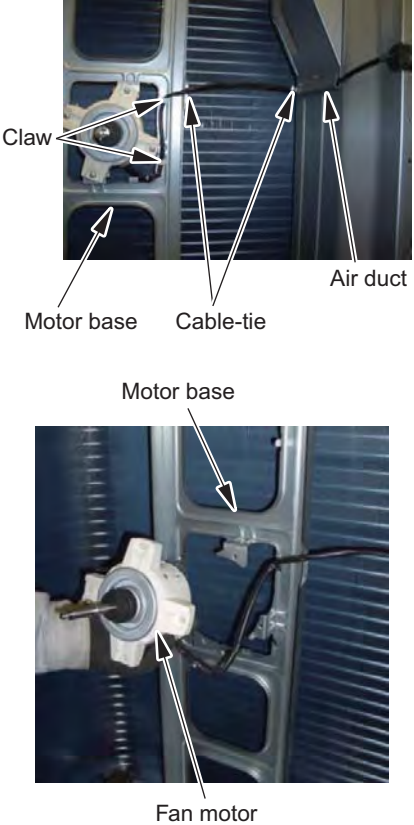
No.	Part name	Procedure	Remarks
(5)	Electrical part (P.C. board) (Continued)	<p>14) Remove a screws fixing heat sink duct and inverter box. (2 pcs, M4 x 8 truss screws)</p> <p>15) Remove the heat sink screw. (3 pcs, M3 x 14 truss screws)</p> <p>16) Remove the inverter box claw being hooking the heat sink duct to remove the heat sink from P.C. board assembly. (The heat sink can be removed with the heat sink duct attached.) It may not be easily to remove the heat sink because the heat sink silicon is coated between the heat sink and sub-heat sink.</p> <p>⚠ CAUTION</p> <p>If dusts or scratches on the surface of the sub-heat sink or heat sink on the removed P.C. board occur, be careful to work as heat dissipation occur, causing the malfunction.</p> <p>17) Remove the P.C. board assembly. (Supporter 5 positions)</p> <p>2. Attachment (P.C. board) Attach the P.C. board in the reverse process of "1. Detachment".</p> <p>*3. Apply the heat sink silicone grease uniformly on the heat sink of P.C. board before installing.</p>	    

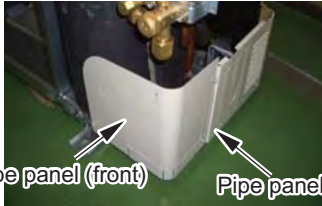
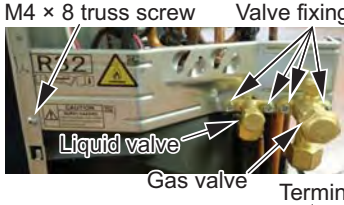
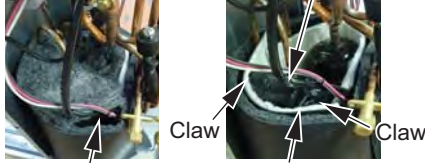
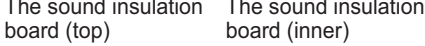
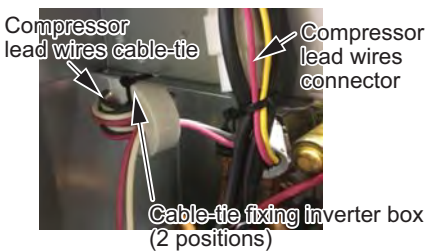
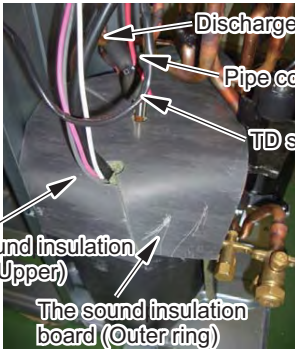

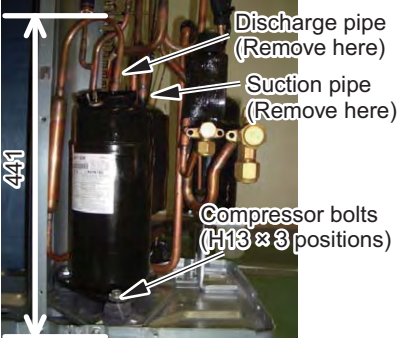

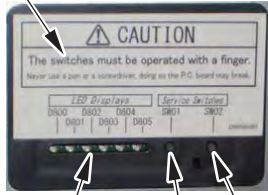
No.	Part name	Procedure	Remarks
(5)	Electrical part (Reactor)	<p>3. Detachment (Reactor)</p> <ol style="list-style-type: none"> Following to work of Detachment of (4). Remove the connector of the reactor lead wire connected to the reactor. (2 positions) Remove the connector. (2 pcs, M4 × 8 truss screws) <p>4. Attachment (Reactor)</p> <p>Attach the reactor in the reverse process of the “3. Detachment (Reactor)”.</p>	
(6)	Fan motor	<p>1. Detachment</p> <ol style="list-style-type: none"> Following to work of Detachment of (1), (2) and (3). Make sure that the fan motor and the propeller fan stop. Remove the flange nut from the fan motor and propeller fan. <ul style="list-style-type: none"> Loosen the flange nut by turning clock wise. (To tighten the flange nut, turn it counter clockwise) Remove the propeller fan. Following to work of Detachment of (5), (1) to (5). <p>5) Cut the cable-tie A4 (Thickness: 1.1 mm, Width: 2.5 mm) bundling the case thermostat lead wires and the reactor lead wires.</p> <p>[Detail C]</p>  <p>6) Remove the connector for the fan motor lead wires. (The clamp filter is removed and used when installing)</p> <p>7) Remove the fan motor lead wires from the fixing rubber for separate plate.</p>	  

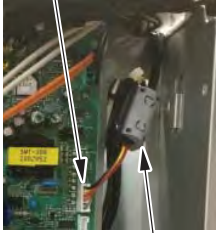
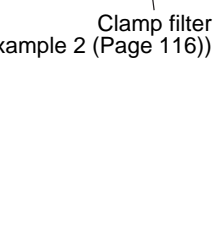

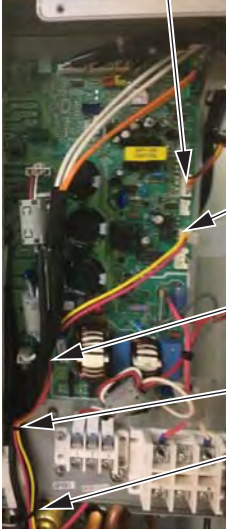
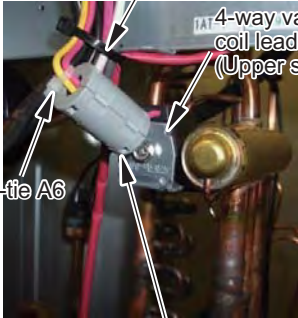
No.	Part name	Procedure	Remarks
(6)	Fan motor (Continued)	<p>8) Cut the cable-tie for the air duct fixing fan motor and the motor base (2 position).</p> <p>9) Loosen the two claws on the motor base.</p> <p>10) Remove the fixing screws (4 positions) while holding the fan motor so as not to fall it. (4 pcs, M4 × 20 sholder screws with captive washer)</p> <p>2. Attachment Attach the Fan motor in the reverse process of "1. Detachment".</p> <p>* Precautions when assembling the fan motor</p> <ul style="list-style-type: none"> • Tighten the flange nut to 4.9 N·m (50 kgf·cm). • To prevent the fan motor lead wires from coming in contact with the propeller fan ensure to adjust the length of the fan motor lead wires fixing rubber so that the fan motor lead wires has no slack. Attach the fan motor lead wires fixing rubber to the partition plate so that the projection is on the refrigeration cycle side. • Ensure to bundle in the part where a cable-tie was removed with a commercially available cable-tie. • Fix the clamp filter again in the place where it has been removed. 	 <p>The top photograph shows the motor base being attached to the air duct. Labels include 'Claw' pointing to the base, 'Motor base' pointing to the base, 'Cable-tie' pointing to the tie, and 'Air duct' pointing to the duct. The bottom photograph shows the fan motor being attached to the motor base. A label 'Fan motor' points to the motor.</p>

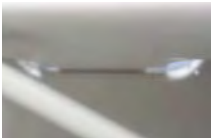
No.	Part name	Procedure	Remarks
(7)	Compressor and compressor lead wires	<p>1. Detachment</p> <p>⚠ WARNING</p> <p>When removing the brazing part of the suction / discharge pipe of the compressor, remove the brazing part in a wellventilated place after recovering the refrigerant. If recovery is insufficient, the refrigerant and refrigerating machine oil may blow, causing injury.</p> <ol style="list-style-type: none"> 1) Recover refrigerant gas. 2) Following to work of Detachment of (1) and (4). 3) Remove the piping panel (front). Remove the screws from piping panel (front) and base plate. (2 pcs, M4 × 10 hexagon screws) Remove the screw from the piping panel (front) and piping panel (rear). (1 pc, M4 × 10 hexagon screw) 4) Remove the piping panel (rear). Remove the screws on the piping panel (rear) and the bottom plate. (2 pcs, M4 × 10 hexagon screws) 5) Remove the valve fixing plate. Remove the screw for the valve fixing plate and partition plate. (1 pc, M4 × 8 truss screw) Remove two bolts at liquid valve side and valve fixing plate. (2 pcs, M6 × 15 deltite screws) Remove two bolts at gas valve side and valve fixing plate. (2 pcs, M6 × 15 deltite screws) 6) Remove the pipe cover and TD sensor fixed with the discharge pipe 7) Remove the sound insulation board (upper, inner, and outer). 8) Remove the compressor' terminal cover (two claws) and compressor lead wires and compressor case thermostat (one claw). 9) Cut the cable-tie fixing the inverter box (two positions) and the other cable-tie rolled around the compressor lead wires. 10) Remove the connector for the compressor lead wires to remove the compressor lead wires. (Keep the ferrite core attached to the electric parts box.) 11) Remove the discharge and suction pipes connected to the compressor using a burner. <p>⚠ WARNING</p> <p>Ensure extreme caution when removing piping by melting the weld with a burner as fire may result if there is any oil within the piping.</p> <p>NOTE</p> <p>Carefully avoid contact with the 4-way valve and PMV with the flame (could result in a malfunction).</p> <ol style="list-style-type: none"> 12) Remove the refrigeration cycle discharge and suction pipes by pulling them upwards. 13) Remove the compressor nuts securing the compressor to the base plate. (H13 × 3 nuts) 14) Pull the compressor forwards. <p>NOTE</p> <p>The compressor weighs at least 15 kg. Ensure two people carry out the work.</p>	 <p>Pipe panel (front) Pipe panel (rear)</p>  <p>M4 × 8 truss screw Valve fixing screws</p> <p>Liquid valve Gas valve</p>  <p>Terminal cover</p> <p>Claw Claw</p>  <p>The sound insulation board (top) The sound insulation board (inner)</p>  <p>Compressor lead wires cable-tie Compressor lead wires connector</p> <p>Cable-tie fixing Inverter box (2 positions)</p>  <p>Discharge pipe Pipe cover</p> <p>TD sensor</p> <p>The sound insulation board (Upper) The sound insulation board (Outer ring)</p>  <p>Claw</p> <p>Compressor lead wires (Red • White • Black) Compressor case thermostat</p>  <p>Discharge pipe (Remove here)</p> <p>Suction pipe (Remove here)</p> <p>441</p> <p>Compressor bolts (H13 × 3 positions)</p>

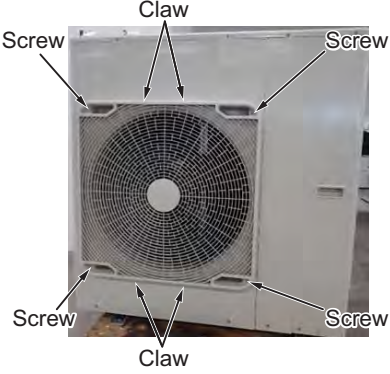
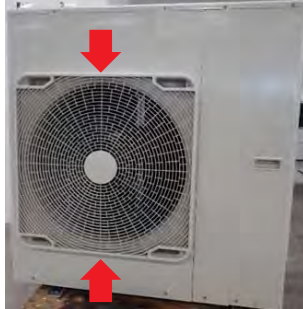
No.	Part name	Procedure	Remarks										
(7)	Compressor and compressor lead wires (Continued)	<p>2. Attachment</p> <p>1) Attach the compressor in the reverse process of "1. Detachment".</p> <p>NOTE</p> <p>Never reuse the compressor lead wires which you disconnected. Use the new one. If you reuse it, it may malfunction.</p> <div style="border: 1px solid black; padding: 5px; margin: 10px 0;"> <p>Install the sound insulation board (inner and outer) through the space between the compressor and the piping, and between the pipes and partition plate as shown on the right.</p> </div> <p>3. Vacuum</p> <p>1) Connect the vacuum pump to the charge port of the liquid and gas pipe valves and the check joint on the high pressure side, and then operate the vacuum pump.</p> <p>2) Vacuum until the vacuum low pressure gauge reaches 1 (mmHg).</p> <p>NOTE</p> <p>Fully open the electronic control valve before the vacuum process. If closed the vacuum pipe between the liquid pipe valve and electronic control valve of the outdoor unit may not be able to be drawn through.</p> <p>Method for forcibly fully opening the electronic control valve</p> <ul style="list-style-type: none"> • Turn on the power supply breaker. • Ensure that D805 of the LED indication of the outdoor is lit up. If D805 is not lit up (off or flashing) then push and hold down SW01 and SW02 at the same time for at least 5 seconds and check that D805 lights up. • Push and hold SW01 down for at least 5 seconds or to confirm that D804 is slowly flashing (once / second). • Push SW01 several times until the LED indications (D800 to D804) become the following. <table border="1" style="width: 100%; text-align: center; border-collapse: collapse;"> <tr> <td>D800</td> <td>D801</td> <td>D802</td> <td>D803</td> <td>D804</td> </tr> <tr> <td>○</td> <td>●</td> <td>○</td> <td>●</td> <td>◎</td> </tr> </table> <p>○: Go ON, ●: Go OFF, ◎: flash (5 times/sec.)</p> <ul style="list-style-type: none"> • Push SW02 and D805 will start rapidly flashing. • Push and hold SW02 down for at least 5 seconds and D804 will start slowly flashing. Once D805 lights up the PMV will start to open. After 30 seconds turn off the power breaker. <p style="text-align: center;">LED indicator</p> <div style="text-align: center;">  <p>D800~D805 SW01 SW02</p> </div> <p>4. Refrigerant encapsulation</p> <p>1) Add the amount of refrigerant determined by the pipe length using the charge port of the valve.</p>	D800	D801	D802	D803	D804	○	●	○	●	◎	<p>Compressor lead wires connector</p> <p>Ferrite core</p> <p>Bundle 4-way valve lead wires, TD sensor, Compressor lead wires, Compressor case thermostat lead wires and Fan motor lead wires to fix them into sheet metal hole on inverter box by cable-tie.</p> <p>Pull out the compressor lead wires, the compressor case thermostat lead wires from this gap.</p> <p>Match the gap on the sound insulation (inner) in front of muffler.</p> <p>Wrap the seam of the sound insulation (inner) and sound insulation (outer) about this position.</p> <p>Push redundant compressor lead, compressor case thermostat lead into a clearance between sound insulation board (inner) and sound insulation board (outer).</p> <p>Suction pipe</p> <p>Match the gap on sound insulation board (outer) to the suction pipe.</p> <p>Pull out the compressor lead wires, the compressor case thermostat lead from the gap of the sound insulation board.</p>
D800	D801	D802	D803	D804									
○	●	○	●	◎									

No.	Part name	Procedure	Remarks
(8)	PMV coil	<p>1. Detachment</p> <ol style="list-style-type: none"> Following to work of Detachment of (4). Cut the cable-tie (two positions) on the back surface Pull the connector for PMV coil out of control P.C. board. (Remove the clamp filter installed to near the connector to attach it to the coil lead wires replaced.) Remove the coil from the PMV body by rotating the coil (about 45°) while drawing the coil upward. <p>2. Attachment</p> <p>Attach the PMV coil in the reverse process of "1. Detachment"</p> <ol style="list-style-type: none"> Fix the coil positioning protrusions securely in the concavities of the PMV body. (Fix the coil in the direction where lead wire comes out at the body's left diagonally behind.) Attach the PMV coil connector to the control P.C. board. (Wind the connector wire to the clamp filter once and attach the clamp filter to near the connector.) <div style="display: flex; justify-content: space-around; margin-top: 10px;"> <div style="text-align: center;">  <p>PMV coil</p> </div> <div style="text-align: center;">  <p>PMV coil connector</p> </div> </div> <div style="text-align: center; margin-top: 10px;">  <p>Clamp filter (Example 2 (Page 116))</p> </div>	<p>Bundle the all lead wires on the back face and then cut the cable-tie fixing inverter box.</p>  <p>Cut the cable-tie bundling up TE sensor Black, TL sensor Blue, TS sensor Gray, Pressure switch (Black tube), Reactor lead wires White, PMV coil lead wires.</p> <p>PMV coil connector</p>  <p>4-way valve coil connector</p> <p>Cable-tie A1</p> <p>Cable-tie A2</p> <p>Cable-tie A5</p>
(9)	4-way valve coil	<p>1. Detachment</p> <ol style="list-style-type: none"> Following to work of Detachment of (5), 1) to 5). Cut the cable-tie A5 bundling up 4-way valve coil lead wires, TD sensor lead wires, Compressor lead wires, Compressor case thermostat lead wires and Fan motor lead wires. Cut the cable-tie A6 fixing the clamp filter. Remove the 4-way valve coil. (M5 screw) <p>2. Attachment</p> <p>Attach the 4-way valve coil in the reverse process of "1 Detachment".</p> <p>*1 Fix the 4-way coil with its lead wires upward.</p> <p>*2 Fix the clamp filter around the 4-way valve coil through a commercially available cable-tie into the hole for fixing cable-tie of clamp filter. (Example 1 (Page 116))</p>	 <p>Cable-tie A5</p> <p>4-way valve coil lead wires (Upper side)</p> <p>Cable-tie A6</p> <p>Clamp filter one time pass</p>

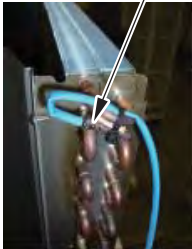
No.	Part name	Procedure	Remarks
(10)	Fan guard	<p>1. Detachment</p> <p>1) Following to work of Detachment of (3).</p> <p>NOTE</p> <p>Perform work on a corrugated cardboard, cloth, etc. to prevent flaw to the product.</p> <p>2) Remove the outlet cabinet and place the fan guard side facing down.</p> <p>3) Remove the screws from the fan guard.</p> <p>4) Remove the hooking claws (4 places) of the fan guard.</p> <p>2. Attachment</p> <p>1) Hook the hooking claws from the front side and press the claws (4 places) by hand to fix them in place. (Push the fan guard in the direction from outside toward center to make the hooking claws to fall.)</p> <p>2) Put the removed screws back to the fan guard. (2 pcs, M4 x 10 hexagon screws)</p> <p>NOTE</p> <p>Check that all the hooking claws are fixed to the specified position.</p>	<div style="display: flex; justify-content: space-around;"> <div style="text-align: center;"> <p>Correct</p>  </div> <div style="text-align: center;"> <p>Incorrect</p>  </div> </div> <div style="text-align: center; margin-top: 10px;">  </div> <div style="text-align: center; margin-top: 10px;">  </div> <div style="text-align: center; margin-top: 10px;">  </div>

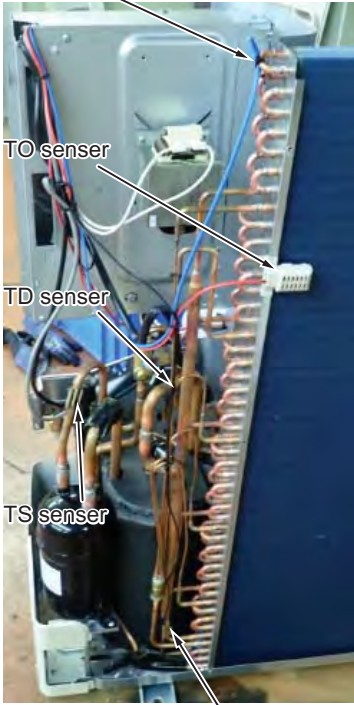
No.	Part name	Procedure	Remarks
(11)	[Reference] Sensor mount positions	<p>1) TD sensor: discharge pipe 2) TL sensor: heat exchanger upside 3) TS sensor: 4-way valve - between accumulator 4) TE sensor: lowest capillary joint 5) TO sensor: Heat exchange surface</p> <p>1) TD sensor  2) TL sensor </p> <p> 3) TS sensor  4) TE sensor</p>	<p>2) TL sensor </p> <p>5) TO sensor</p> <p>1) TD sensor</p> <p>3) TS sensor</p> <p>4) TE sensor</p>

14 EXPLODED VIEWS AND PARTS LIST

14-1. Outdoor Unit

RAV-GP561ATW-E, RAV-GP561ATW-TR

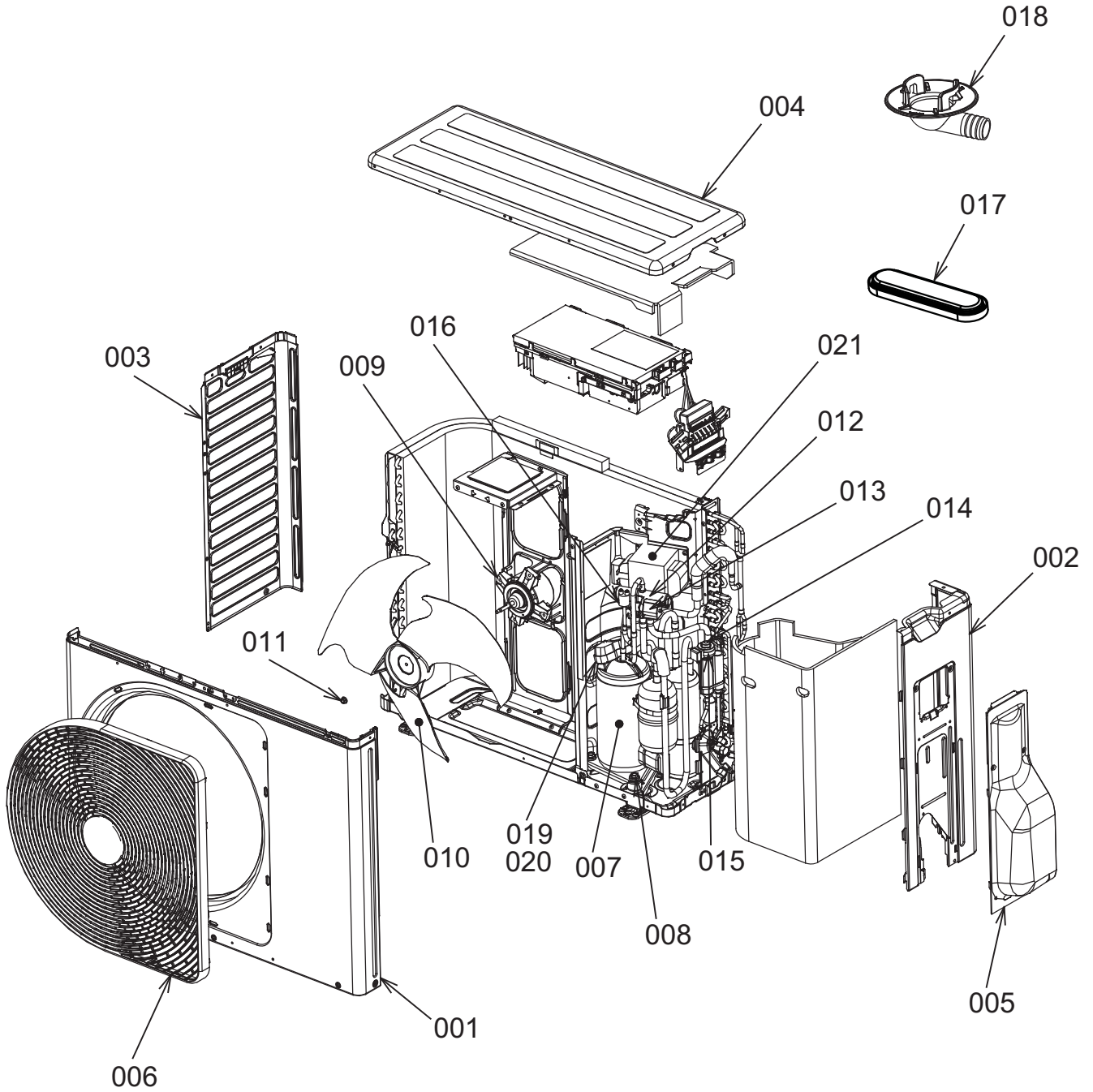

Location No.	Part No.	Description	Q'ty/Set RAV-GP	
			561ATW-E	561ATW-TR
001	43P00012	PANEL, AIR OUTLET, ASSY	1	1
002	43P00013	PANEL, SIDE, RIGHT, ASSY	1	1
003	43P00014	PANEL, SIDE, LEFT, ASSY	1	1
004	43P00015	PANEL, ROOF, ASSY	1	1
005	43P00016	COVER, PACKED, VALVE	1	1
006	43P19003	GUARD, FAN	1	1
007	43P42004	COMPRESSOR, ASSY (WITH COMPRESSOR LEAD)	1	1
008	43P42003	BOLT, COMPRESSOR	3	3
009	43P21002	MOTOR, FAN, ICF-140-A43-1	1	1
010	43P20002	FAN, PROPELLER, PJ441-E	1	1
011	43P97001	NUT, FLANGE	1	1
012	43P46014	VALVE, 4WAY, STF-H0218	1	1
013	43P46013	COIL, VALVE, 4WAY, STF-H01AZ1724A1	1	1
014	43P46008	VALVE, PMV, DPF1.5C-0.4	1	1
015	43P46009	COIL, PMV, PQ-M10012-000313	1	1
016	43P51004	SWITCH, PRESSURE, ACB-4UB154W	1	1
017	43P79008	CAP, WATER-PROOF	2	2
018	43P19002	NIPPLE, DRAIN	1	1
019	43P50007	THERMOSTAT, BIMETAL	1	1
020	43P42002	HOLDER, THERMO	1	1
021	43P58002	REACTOR, CH-102	1	1

RAV-GP801ATW-E, RAV-GP801ATW-TR

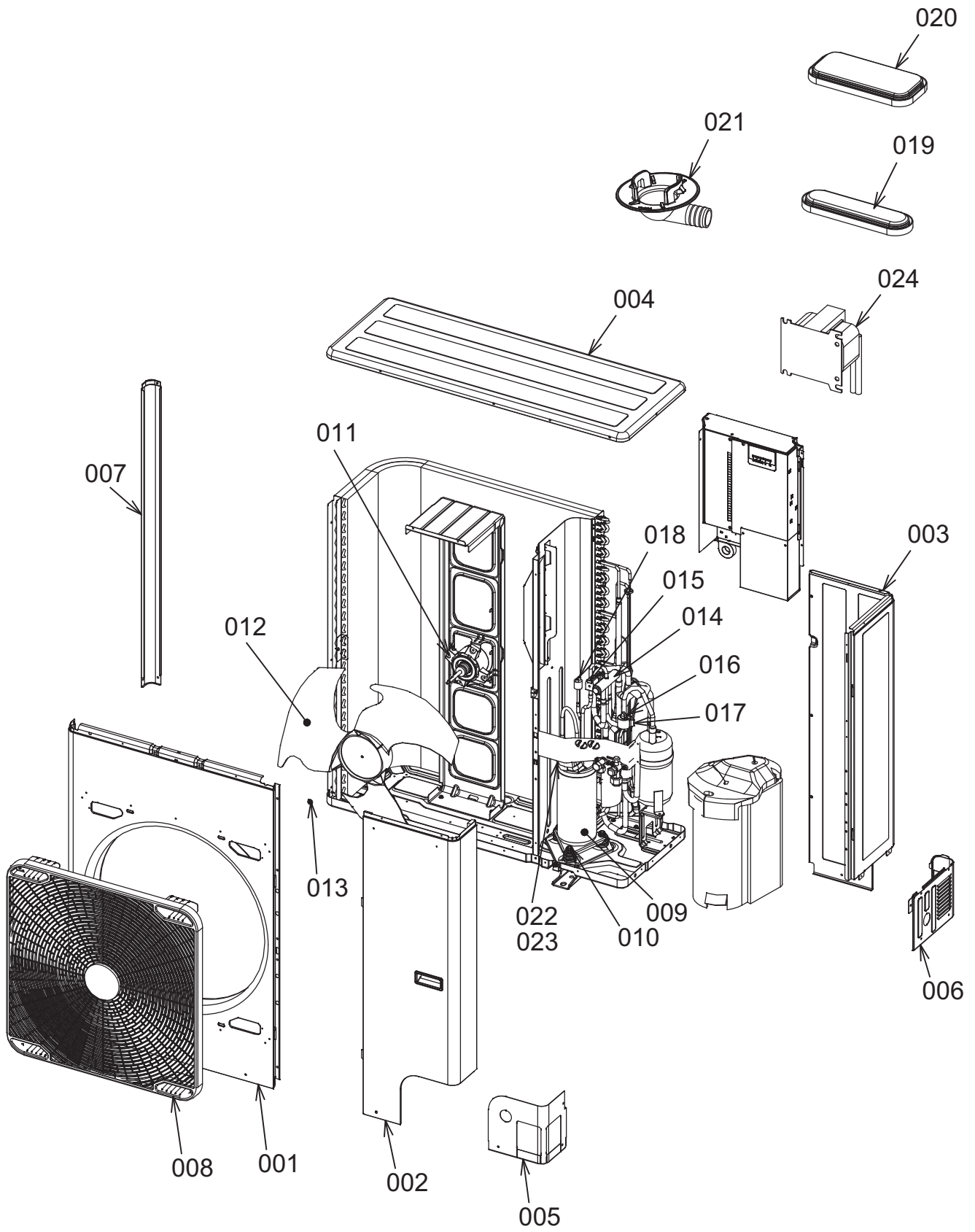

Location No.	Part No.	Description	Q'ty/Set RAV-GP	
			801ATW-E	801ATW-TR
001	43P00005	PANEL, AIR OUTLET	1	1
002	43P00006	PANEL, FRONT, ASSY	1	1
003	43P00007	PANEL, SIDE, RIGHT, ASSY	1	1
004	43P00008	PANEL, ROOF, ASSY	1	1
005	43P00009	PANEL, FRONT, PIPING	1	1
006	43P00010	PANEL, BACK, PIPING, ASSY	1	1
007	43P00011	STAY	1	1
008	43P09001	GUARD, FAN	1	1
009	43P42006	COMPRESSOR, ASSY (WITH COMPRESSOR LEAD)	1	1
010	43P42001	BOLT, COMPRESSOR	3	3
011	43P21001	MOTOR, FAN, ICF-280-A60-1	1	1
012	43P20001	FAN, PROPELLER, PS561-E	1	1
013	43P97001	NUT, FLANGE	1	1
014	43P46014	VALVE, 4WAY, STF-H0218	1	1
015	43P46013	COIL, VALVE, 4WAY, STF-H01AZ1724A1	1	1
016	43P46001	VALVE, PMV, UKV-18D301	1	1
017	43P46002	COIL, PMV, UKV-A040	1	1
018	43P51005	SWITCH, PRESSURE, ACB-4UB83W	1	1
019	43P79008	CAP, WATERPROOF	1	1
020	43P79009	CAP, WATERPROOF	4	4
021	43P19002	NIPPLE, DRAIN	1	1
022	43P50007	THERMOSTAT, BIMETAL	1	1
023	43P42002	HOLDER, THERMO	1	1
024	43P58001	REACTOR, CH-101	1	1

14-2. Inverter Assembly

RAV-GP561ATW-E, RAV-GP561ATW-TR

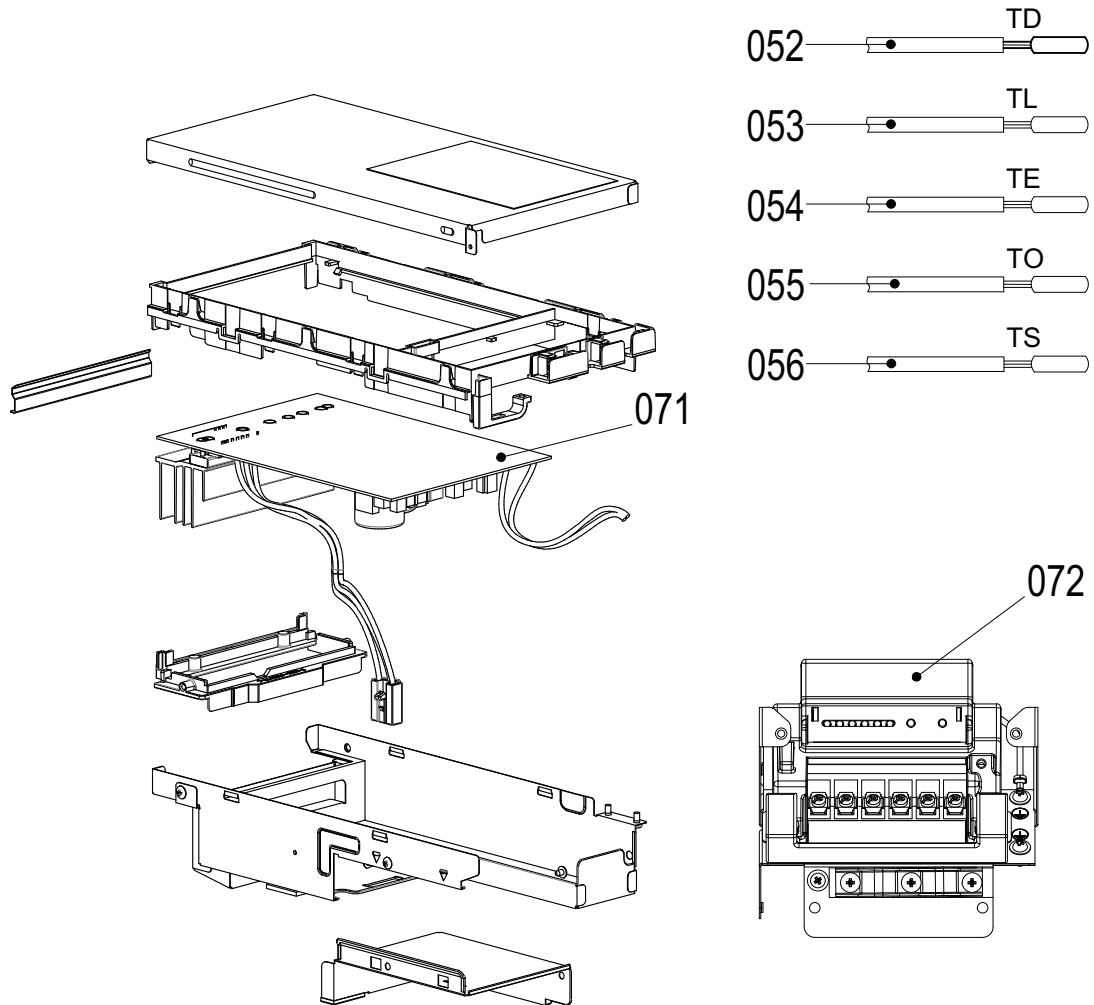

Location No.	Part No.	Description	Q'ty/Set RAV-GP	
			561ATW-E	561ATW-TR
052	43P50012	SENSOR, TD	1	1
053	43P50013	SENSOR, TL	1	1
054	43P50010	SENSOR, TE	1	1
055	43P50004	SENSOR, TO	1	1
056	43P50011	SENSOR, TS	1	1
071	43P69008	PC BOARD ASSY, MCC1768	1	1
072	43P69002	PC BOARD ASSY, MCC1646, TERMINAL BLOCK	1	1

RAV-GP801ATW-E, RAV-GP801ATW-TR

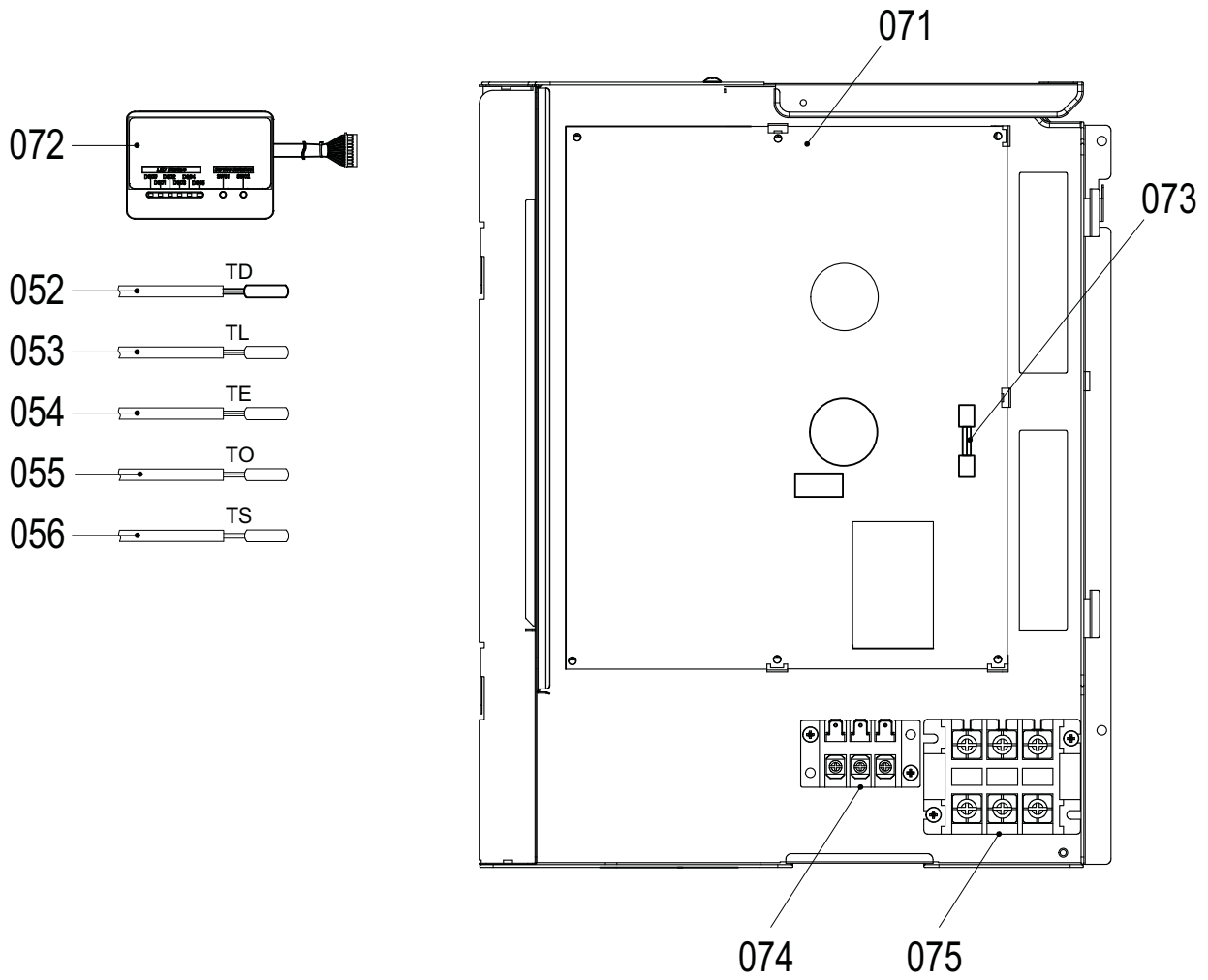

Location No.	Part No.	Description	Q'ty/Set RAV-GP	
			801ATW-E	801ATW-TR
052	43P50002	SENSOR, TD	1	1
053	43P50003	SENSOR, TL	1	1
054	43P50004	SENSOR, TE	1	1
055	43P50005	SENSOR, TO	1	1
056	43P50006	SENSOR, TS	1	1
071	43P69009	PC BOARD ASSY, MCC1705	1	1
072	43P69007	PC BOARD ASSY, MCC1646	1	1
073	43P60001	FUSE, 10A	1	1
074	43P60002	TERMINAL BLOCK, 3P, 20A	1	1
075	43P60003	TERMINAL BLOCK, 3P, 60A	1	1

Toshiba Carrier Air-Conditioning Europe Sp.z o.o.

ul. Gdańska 131, 62-200 Gniezno, Poland

Copyright © 2021 Toshiba Carrier Air-conditioning Europe Sp. z o.o. All Rights Reserved.

Revision record

First issue	—	—	Apr., 2021
Revision 1	Expression and text were revised.	Page 114	May, 2021